



Goosenecks

Fifth Wheels

Louvered Tailgates

Ball Mounts

Receiver Tubes

Solid Shanks Straight

Pintles & Accessories

Pins & Locks

Hitch Balls

Trailer Hitches

Tow Dollies

Mirrors

Hitch Covers

Hitch Safe

Wheel Covers

TRAILER HITCHES AND ACCESSORIES

DOUBLE LOCK

Gooseneck Hitch



C-600

The CURT Double-Lock Gooseneck Hitch offers an effortless and highly dependable hitch for your Gooseneck Trailer. Feel secure with the "Double-Lock" security system and when you are not towing, the trailer ball removes for complete access to your truck bed.



C

Part #	GTW/TW	Finish	Description
CUC-60	30,000/6,000	Carbide	Double-Lock Gooseneck Hitch - for use with CUC-30 Series Installation kits
CUC-600	30,000/6,000	Carbide	Double-Lock Gooseneck Hitch for use with CUC-600 Series Installation kits
CUC-615	30,000/6,000	Carbide	Double-Lock Gooseneck Hitch for 07-08 New Body Chev 1500 ONLY - for use with CUC-632 Series Installation kits
CUC-620	30,000/6,000	Carbide	Double-Lock Gooseneck Hitch for Nissan Titan ONLY - for use with CUC-664 Series Installation kits
CUC-625	30,000/6,000	Carbide	Double-Lock Gooseneck Hitch for Toyota Tundra ONLY - for use with CUC-665 Series Installation kits

- 30,000 lb gross towing weight, 6,000 lb tongue weight
- Removable chrome 2 5/16" trailer ball
- Double-Lock Security
- Attractive Chrome Plated Trim Ring included
- Fits in the same mounting kits as the CURT Quick Goose 2 Hitches
- Durable Powder Coat Finish
- Safety chain hook-ups included
- Heavy duty engagement system
- 4" hole size
- No welding required
- No bed removal required to install

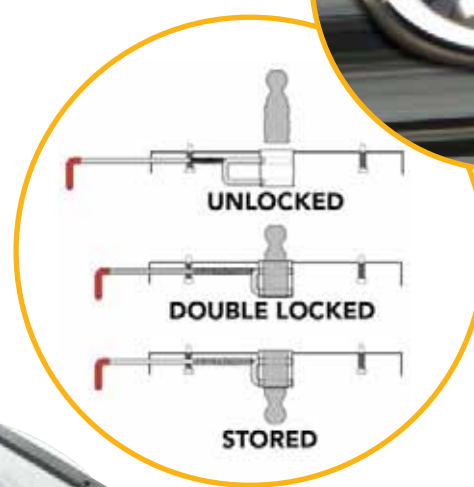

Custom Mounting Assembly Kits for many vehicle applications Sold Separately.





Quick Goose 2™ Gooseneck Hitch

Assembly kit sold separately

PKG #	GTW/TW	Finish	Description
CUC-300 (C-30 old #)	30,000/6000 lb	Carbide	Quick Goose 2™ - for use with 30 Series Installation Kits
CUC-400 (C-40 old #)	30,000/6000 lb	Carbide	Quick Goose 2™ - for use with 30 Series Installation Kits <i>(for most Dodge Ram Trucks - See Application Guide)</i>
CUC-630	30,000/6000 lb	Carbide	Quick Goose 2™ - for use with 600 Series Installation Kits
CUC-640	30,000/6000 lb	Carbide	Quick Goose 2™ - for use with 600 Series Installation Kits <i>(for most Dodge Ram Trucks - See Application Guide)</i>

SEE APPLICATION GUIDE FOR MAKE & MODEL INSTALLATION KITS

Replacement Parts for Quick Goose	
Part #	Description
CUC-105	CLEVIS PIN FOR QUICK GOOSE
CUC-106	CLEVIS PIN FOR QUICK GOOSE
CUC-107	BOWTIE CLIP FOR CLEVIS PIN
CUC-108	BLACK HANDLE COVER 1/2 IN X 5
CUC-109	RED HANDLE COVER 1/2 IN X 5 1
CUC-111	QUICK GOOSE REPLACEMENT BALL
CUC-112	QUICK GOOSE CHROME COLLAR WIT
CUC-113	SAFETY CHAIN U-BOLT KIT FOR Q
CUC-114	LIFT ROD SPRING
CUC-115	BALL LOCK ROD SPRING
CUC-116	FLIPPER/PUSH BAR RIGHT HAND F
CUC-117	LINKAGE
CUC-118	PULL ROD (LEFT) C-30
CUC-119	PULL ROD (RIGHT) C-30
CUC-120	BALL CHOKER
CUC-121	PULL ROD (LEFT) C-40
CUC-122	PULL ROD (RIGHT) C-40
CUC-123	T-HANDLE WITH COTTER PIN FOR
CUC-127	CHROME PLATED STEEL CAP FOR C
CUC-128	CARRIAGE BOLT FOR C-52
CUC-130	REPLACEMENT BALL CHOKER FOR Q
CUC-140	REPLACEMENT ROD, BLACK SIDE,
CUC-145	RUBBER COVER FOR C-30 & C-40
CUC-150	INSTALLATION TEMPLATE FOR C-5
CUC-165	REPLACEMENT CAP FOR C-60

U.S. Patent No.
5016898

Turnover Ball™ Gooseneck Hitch



A Hitch When You Need It...

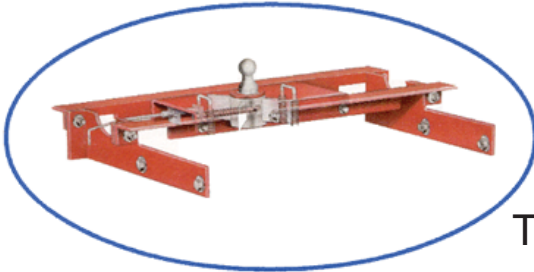

- Limited-Lifetime Warranty
- 30,000 GTW
- 7,500 VTW
- Converts in Seconds
- 7 Towing Accessories

Turnover Ball Model Chart in Fit guide
...A Level Bed When You Don't

- Installs Under the Bed
- Bolts into Existing Holes in the Frame
- No Welding or Bed Removal
- Requires only a 4" hole in the Truck Bed
- Safety Chain Brackets and Mounting Hardware Included.

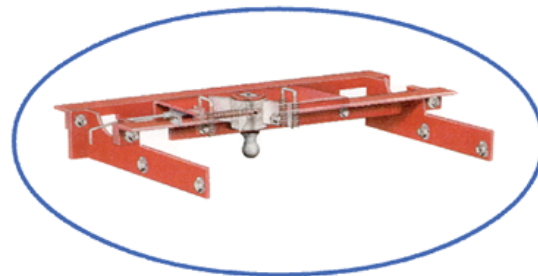

TURNOVER BALL

 BW1600	 BW1700
 BW2000	 BW3050
 BW2025	 BW2050
 BW3000	 BW4000

Part Number	Description
BW1500	FLAT BED KIT 1 PIECE WELDING NEEDED
BW1600	SAFETY CHAIN U BOLT KIT CONSISTS OF 2 UBOLTS ,SPRINGS,& LOCK NUTS
BW1700	Plug
*BW1900	Latch Pin Handle
BW2000	REPLACEMENT BALL 2 5/16 GNXA2000
BW2025	3" Ball
BW2050	Hi-Rise Ball (Rated at 20,000 lbs.)
BW3000	Companion 5th Wheel RV Hitch kit
BW3050	Companion 5th Wheel RV Hitch kit for atbeds
BW4000	King Pin 30K
*BW4025	Inverted Ball
*BW4075	Eyelet
BW4085	Gooseneck extender
BW4585	Toyota 4" gooseneck ball extender



Turnover Ball Model Chart in Fit guide

Pop up 2

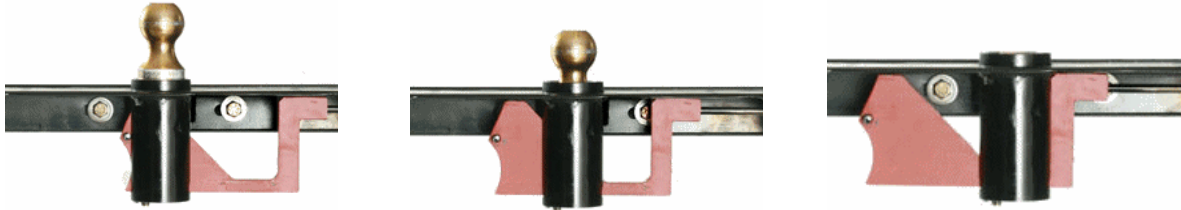

You're going to love this newly redesigned PopUp Hitch. Smoother acting and trouble free. We've made the best hitch even better. So simple you'll wonder why you didn't think of it. One pull of the handle to raise the ball is all it will take to convince you that this is the hitch you want. Try it and see.

We've replaced the cam mechanism with a simple yet strong and reliable slide to raise and lower the ball. Simply pull the rod to raise the ball and push to lower it.

When in the fully raised position, the ball is locked in place assuring that it can't fall down by it's self. To lower the ball, push rod firmly with the heel of your hand to over-ride the latch.

The PopUp2 is now available for the popular Toyota Tundra as well as Chevy, Ford and Dodge.

Raise and Lower the Ball From the Wheelwell of Your Truck

- Raise or hide ball instantly with rod in rear wheel well of truck.
- 30,000 lbs. Gross Trailer Weight.
- 7,500 lbs. Gross Tongue Weight
- 2-5/16" ball..
- Hitch ball fits in 3" hole in bed. None smaller.
- Bolts in place using existing frame holes.
- Includes spring loaded safety chain anchors.
- Installs quickly without loosening bed.
- No welding or fabrication.
- Grade 5 and 8 installation hardware provided..
- 100% complete.

SEE FIT GUIDE FOR APPLICATIONS

* = Special Order/Non-stock

C

Flip-Over™ Flip-Over Invertible Ball Gooseneck Hitch

- Converts to a smooth bed or a gooseneck ball in **seconds** - just rotate the handle and Flip the ball over
- 30,000 lb. Gross Trailer Weight, 7,500 lb. Gross Tongue Weight
- Precisely designed for each truck - installs with truck bed in place
- 3-1/2" hole in truck bed floor - bolt-in installation uses existing holes
- 100% complete - spring loaded safety chain anchors included



Ball Rotates in Socket for Extended Life.



****ALL FLIP_OVER KITS AVAILABLE BY SPECIAL ORDER**

Flip-Over™ Flip-Over Invertible Ball Accessories



PUFL1005
Replacement ball. Machined from 1045CF steel, yellow zinc chromate plated.



PUFL1005B
Hi-Rise ball has 2" neck. Machined from 1045CF steel, yellow zinc chromate plated.



PUFL2
Standard King-Pin accessory fits Flip-Over Invertible Ball socket.



PUFL8

FL4 4" REARWARD OFFSET 2 5/16" BALL POPUP BRAND
20K FOR SHORT BED CLEARANCE



C

POP UP



Folding Ball Gooseneck Hitch

- 30,000 lb. GTW
- 6,000 lb. Tongue Capacity
- 3/8" Top Plate, 6 Hole Bolt Pattern
- U-Bolt Safety Chain Hook-ups (included)
- Stainless Steel Safety Pin
- Durable powder coat finish resists rust & corrosion
- No Tools Needed To Fold
- T-Handle for ease of use
- Easy access To Grease fitting
- Stainless Steel Pivot Spring
- Mounting Hardware included
- Easy To Follow Installation Instructions
- Attractive Display Packaging
- Cutting Template Included (paper)
- U.S. patent #'s 5,571,270; 5,755,452; 5,435,585

Part #	GTW/TW	Finish	Description
CUC-52	30,000/6,000	powder coat	2 5/16" folding ball hitch complete with U-bolt kit

CURT Manufacturing Inc. has developed the only trouble-free folding ball hitch with a stainless steel spring loaded safety pin incorporated into the ball to prevent the door from becoming ajar during towing on rough unstable terrain.

To make installation simple, CURT Manufacturing Inc. has designed Custom Frame Installation Kits for Chevy, Dodge, Ford and Toyota full size pickups.



**2 Step
easy set-up
or storage**

PULL

PUSH

**Ball folds
down and
out of
the way**



Folding Ball Hitch Installation Kits

FOR USE WITH CURT'S C-52, C-10, AND C-55

- Laser Cut For Precise Fit
- 20,000 lb. & 30,000 lb. rated kits available for most applications
- Grade 5 Mounting Hardware
- Easy to Follow Installation Instructions



Vehicle Make	Part# 20k GTW	Part# 30k GTW	Description
Chevrolet/GM	CUC-231	CUC-331	07-08 1500 New Body long or short bed
Chevrolet/GM	CUC-241(C-218*)	CUC-341(C-318*)	99-07 1500/2500 LD, ALL, (Classics only in 07) ✗ 01-08 3500 HD (New & Classic Bodies) ✗ 01-08 2500 HD (New & Classic Bodies) ✗
Chevrolet/GM	CUC-2CL	CUC-503	88-98 1500/2500/3500, 99-00 Old Body, long bed
Chevrolet/GM	CUC-2CS	CUC-504	88-98 1500/2500/3500, 99-00 Old Body, short bed
Dodge	CUC-219 (C-19*)	CUC-319 (C-519*)	02-08 RAM 1500, ALL beds ✗
Dodge	CUC-20	CUC-520	03-08 RAM 2500/3500, ALL beds, incl. MegaCab
Dodge	CUC-9	CUC-509	94-01 RAM 1500 ALL, 94-02 2500/3500 ALL
Ford	CUC-222 (C-22*)	CUC-322 (C-522*)	99-08 F-250/350 SuperDuty ALL incl air-bag overloads ✗
Ford	CUC-222 (C-22*)	CUC-322 (C-522*)	2008 F-450 SuperDuty ALL incl air-bag overloads ✗
Ford	CUC-221 (C-21*)	CUC-321 (C-521*)	04-08 F-150, ALL BEDS ✗
Ford	CUC-6	CUC-506	97-03 F-150 ALL, 97-98 F-25, 04 Heritage
Ford	CUC-2F	CUC-505	80-96 F-250/350, 97-98 F-250/350 w/o overload springs 80-96 F-250/350, 97-98 F-250/350 w/overload springs 80-96 F-150, ALL
Toyota	CUC-225**	--	2007 Tundra Short Bed
Universal	CUC-2	CUC-502	UNIVERSAL RAIL KIT, RAW FINISH

*While supplies last. Does not fit 07-08.

** Do Not Exceed Recommended vehicle towing capacity

Also Available:
CUC-150
Steel Cutting
Template



Folding Ball Replacement Parts

CUC-103	C-52 Replacement Hitch Ball
CUC-104	Spring for Folding Hitch Ball Door
CUC-113	Safety Chain U-Bolt Kit (Note: C-52 comes complete with U-bolt kit)
CUC-123	Replacement T-handle w/cotter pin
CUC-128	Pivot bolt and nut assembly
CUC-150	Installation template, steel cutting guide

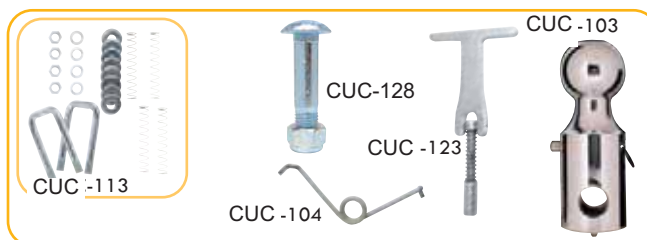

C
CURT FOLDING BALL GOOSENECK

* = Special Order/Non-stock



GOOSENECK ADAPTERS



PART NO	Description	O.D.	Travel	Cap.
GNA3125	Goosneck Adapter w/ remote cable Will Change 5th Wheel to Gooseneck Trailer 2-5/16"	4"	3"	24K
GNA3139	**8" EXTENDED GOOSENECK ADPTR COMPLETE RANCH HITCH ADAPTER ADAPTS 5TH WHEEL TO GOOSENECK BALL REMOTE CABLE RELEASE 24,000GVWR 6,000 TW 3" VERT. ADJ & 8" OFFSET Special Order Only			
SB1BD	Short Bed Ext. 2-5/16" Coupler Outer Tube Not Included 9" Same as SB1 with thru pin for new Bulldog			
SB2	Short Bed Gooseneck 2-5/16 Coupler Outer Tube Not Incl. Extends 9 more Inches, 25,000 lbs Cap. Square Tube	4.5"		

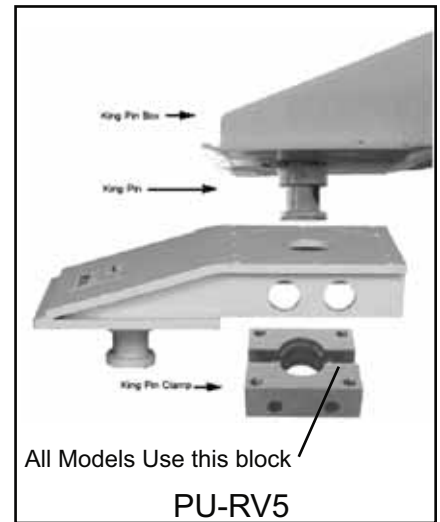

PART NO	Description
PU-RV1	Fifth Wheel Gooseneck Adapter. Fitted with 2 5/16" coupler. 5" Offset, 4" Height adjustment in 1" increments. 24K gross trailer weight; 6K tongue weight includes coupler, release cables and hardware.
PU-RV2	Fifth Wheel Gooseneck Adapter. Fitted with 2 5/16" adapter, 9" Offset, 24K gross trailer weight; 6K tongue weight includes coupler, release cables and hardware.
PU-RV3	Fifth Wheel Gooseneck Adapter with No Offset. The PopUp RV3 has all the features and towing advantages of the RV1 and RV2 with NO OFFSET! The RV3 locates the king-pin directly over the gooseneck hitch ball for truck and trailer combinations that do not require the added trailer swing and maneuverability a 5" or 9" offset provides. Fits standard king-pin box; 4" height adjustment in 1" increments; Powder coated finish; Easy bolt-on installation; 24K gross trailer weight; 6K gross tongue weight.
PU-RV4	Fifth Wheel Gooseneck Adapter with Fixed 7.5" height. and 9" Offset. The PopUp RV4 will let you pull your RV trailer with a 2 5/16" gooseneck ball even if your tow vehicle bed is tall, as is usually the case with flat beds. The RV4 has a fixed height of only 7-1/2" and provides a full 9" of rearward offset for increased trailer swing and maneuverability. Easy bolt-on installation; 24K Gross Trailer Weight; 6K Gross Tongue Weight.
PU-RV5	Easily add 10": more clearance between truck and trailer; more trailer swing easier maneuvering; Fits standard king pin box; One hour bolt-on installation; White powder coated finish; 24K gross trailer weight; 6K gross tongue weight.



CC1 - Up to 4,000 lbs. Gross Tongue Weight.
 CC2 - Up to 8,000 lbs. Gross Tongue Weight.
 CC1 & CC2 - Up to 24,000 lbs. Gross Trailer Weight.

Progressive shock dampening cushions.

Less driver and passenger fatigue.

Less animal fatigue.

Less wear and tear on truck and trailer.

Maintenance free.

Lifetime warranty on Timbren cushions.

Fits 4" I.D. round coupler tube.

Simple swap-out installation.

Precision laser cut fabrication.

Self-latching GN8 2-5/16" "V-19" rated coupler.

GN8 Coupler rated at 28,000 pounds.

Long lasting black powder coated finish.

100% complete.

Part Number	Description
CC1	GOOSENECK CUSHION COUPLER 4K
CC2	GOOSENECK CUSHION COUPLER 8K
CC4	EXTENDED CUSHION COUPLER 8K
GN1 BD	COUPLER & TUBE, GOOSENECK 2 5/16" COUPLER 4"OD TUBE 24" LONG 28K
GN5BD	KING PIN & TUBE W/THROUGH PIN HOLES FOR BULLDOG 18" LONG SCD80 4" OD
GN6	GOOSENECK TO KING PIN 4.5"OD SQUARE ADAPTER PIPE 20" SLIDE 1" HOLES
GN7	GOOSENECK TO KING PIN 4"OD SQUARE ADAPTER 4" od PIPE 20"SLIDE 1 1/8" ADJ HOLES
GN8	SELF-LATCHING 2-5/16" COUPLER FITTED TO 4" X 24" HEAVY WALL ROUND TUBE. (SCHEDULE 80) WHITE POWDER COAT FINISH. FITS STANDARD 4" I.D. GOOSENECK TRAILER COUPLER TUBES. COUPLER "V-19" RATED 28,000 POUNDS.

GOOSENECK ADAPTERS C



* = Special Order/Non-stock

REMOVE-A-BALL, GOOSENECK INSTALL KITS



6300



2 5/16" Remove-A-Ball Gooseneck Hitch Platform Ball & Magnetic Cover Included.
7,500 lb. Tongue / 30,000 lb. Gross Capacity

- 5983 DRAWTITE GOOSENECK HITCH (REPLACEMENT MAGNETIC COVER)
- 6303 (3" REPLACEMENT BALL)
- 6352 (BALL STORAGE BAG FOR 2 5/16" & 3" BALLS)
- 5973 2 5/16 REPLACEMENT BALL
- 6467 TEMPLATE
- 6308 REPLACEMENT U-BOLT KIT FOR 6300 GOOSENECK

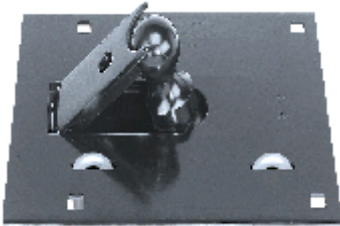

075064



Folding 2 5/16" Ball Gooseneck Hitch Platform 25,000 lb. Gross Capacity Installation requires An 8" x 11 1/2" Hole In the bed To mount The Heavy-Gage Steel Assembly To The Vehicle Frame For Secure Installation. Use of Valley Rail Kits Below Required.

Use of Draw-Tite Only Rail Kits Below Required

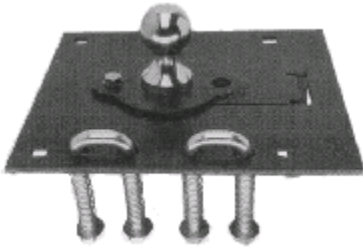

Folding 2 5/16" Ball Gooseneck Hitch Platform 5,000 lb. Tongue / 25,000 lb. Gross Capacity Utilizes a 360 Degree Locking Collar That Secures The Ball To Prevent Ball Roll-Over When in Operation. Optional Safety Chain U-Bolt Kits Are Also Available.

- BG9003 Buyers Gooseneck Hitch
- BRB03 Shown Installed - 4 Bolt Kit not included
- BRB04 Dodge Kit - 4 Bolt Kit

GOOSENECK INSTALLATION RAIL KITS

Rated to Match Manufacturers Vehicle Weight Ratings
No Need to Raise Truck Bed on Most Models
Spacer Shims Included to Protect Truck Bed Corrugation
Simple Bolt on Application, No Welding Necessary.

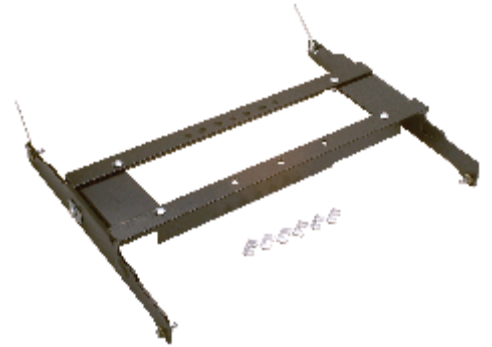

Atwood utilizes the same rail kits.
Buyers and Drawtite use only like branded rail kits.

Make	Years	Model	Rail Kit	Notes	Below-Bed		Above-Bed		
					Complete Kit	Head Only	Head Only	Head Only	
Chevy/GMC	88-00	Old Body Style, 6' & 8' Beds	4440	1	9461-40	9461	6300	83399	
	99-07	1500 LD (Classic), 6' & 8' Beds	4431		9461-31	9461	6300	83399	
	07-09	1500 LD, 6' & 8' Beds (New Body Style)	4431		9461-31	9461	6300	83399	
	01-07	1500 HD (Classic), 6' Bed	4431		9461-31	9461	6300	83399	
	99-04	2500 LD, 6' Bed	4431		9461-31	9461	6300	83399	
	99-04	2500 LD, 8' Bed	4434		9461-34	9461	6300	83399	
	01-07	2500 HD (Classic), 6' & 8' Beds	4434		9461-34	9461	6300	83399	
	07-09	2500 HD, 6' & 8' Beds (New Body Style)	4434		9461-34	9461	6300	83399	
	01-07	3500 Series (Classic)	4445		9461-45	9461	6300	83399	
	07-09	3500 HD, 6' & 8' Beds (New Body Style)	4434		9461-34	9461	6300	83399	
	Dodge	94-01	1500/2500/3500, 6' & 8' Beds	4439		9460-39	9460	6300	83399
		02-08	1500 Only, Includes Mega Cab	4438		9464-38	9464	6300	83399
		06-08	1500 Mega Cab w/6' Bed	4435		9464-35	9464	6300	83399
2009		1500, Except Mega cab	4446		9464-46	9464	6300	83399	
2002		2500, 6' & 8' Beds	4439		9460-39	9460	6300	83399	
03-09		2500 HD, Includes Mega Cab	4435		9464-35	9464	6300	83399	
2002		3500, 8' Bed	4439		9460-39	9460	6300	83399	
03-09		3500 HD, Includes Mega Cab & Dually	4435		9464-35	9464	6300	83399	
Ford	04-09	F-150, 6' & 8' Beds	4437		9461-37	9461	6300	83399	
	99-09	F-250/F-350 Super Duty (Except Cab & Chassis)	4430		9460-30	9460	6300	83399	
	2008	F-450 Super Duty (Except Cab & Chassis)	4443		9460-43	9460	6300	83399	
	Toyota	07-08	Tundra, except Crew max w/5-1/2" Bed	4436		9461-36	9461	N/A	N/A

Note: Will not fit trucks with beds shorter than 6' in length or Flareside / Stepside. Rail Kits are rated to match manufacturer's vehicle tow weight ratings

1 - Will not fit 1988-91 4 Dr. Crew Cab models

- | | | |
|------------------|-------------------------------------|-------------|
| FORD | | |
| 1980-98 | F-250 & F-350 old body style | 5928 |
| 1998-00 | F-150 F-250 | 5930 |
| 2001-03 | F-150 | 5930 |
| CHEVY/GMC | | |
| 1988-98 | 1500 2500 Old body style LB | 5926 |
| 1988-98 | 1500 2500 Old body style SB | 5927 |
| 1999-03 | 1500 2500 & 2500HD long & short bed | 5932 |
| 1988-00 | 3500 LB | 5926 |
| 2001-03 | 3500 long & short bed | 5932 |
| DODGE | | |
| 1994-01 | Dodge Pickup 1500, 2500, 3500 | 5929 |

Gooseneck Hitch Plate

- 5/16 Steel Plate Construction
- 2 5/16 Towing Ball
- Black Powder Coated for Corrosion Resistance
- Capacity 25,000 lbs. MGTW
- No Mounting Hardware Included

G9542

2 5/16" Gooseneck Hitch Plate



25K Gooseneck Hitch

- 25,000 lbs. Capacity
- Utilizes Same Base Rails as Our 15K and 16K 5th Wheel Hitches
- Durable Powder Coat, Black Paint Finish
- Easy Installation and Removable – Allow Full Access to Truck Bed
- 2 5/16" Heat Treated Ball

6002 & 30035 (Sold Separately)
Universal Kit - See page C-13
for Custom Brackets



50223
Chain bracket kit for gooseneck
Fits Draw-Tite and Reese Rails



Draw-Tite 40845
SIGNATURE SERIES GOOSENECK
30K 2 5/16 BALL ON STEEL BASE
W/ PLASTIC COVER
RAILS NOT INCLUDED

49080

Pro Series Gooseneck
rails sold separately see 30035



30035 Rail Kit
FIFTH WHEEL RAILS W/ UNI BRKTS
REESE/DRAWTITE

Universal Fifth Wheel Base Rails

• Drill Required



Part #	Description	Finish
CU16100	2 Universal 5th Wheel Base Rails (includes CU16104 and CU16101)	Gloss Black
CU16104	2 Universal 5th Wheel Base Rails ONLY (Brackets & Hardware Kits not included)	Gloss Black
CU16200	2 Universal 5th Wheel Base Rails (includes CU16204 and CU16101)	Carbide Black
CU16204	2 Universal 5th Wheel Base Rails ONLY (Brackets & Hardware Kits not included)	Carbide Black
CU16101	Universal 5th Wheel Rail Mounting Hardware Kit. Universal brackets and hardware included.	



C
GOOSENECK HITCH



CURT Gooseneck Bent Plate

- 25K Towing Capacity
- Mounts to all standard 5th Wheel Rails
- Durable Powder Coat Finish resists rust & corrosion
- Easy 4 locking pin installation and removal allows full access to truck bed

Bulk #	PKG#	Finish	GTW
CU16055	--	powder coat	25,000



CURT Spyder Gooseneck

- 25K Towing Capacity
- Mounts to all standard 5th Wheel Rails
- Durable Powder Coat Finish resists rust & corrosion
- Easy 4 locking pin installation and removal allows full access to truck bed
- Safety chain hook-ups
- 2 5/16" trailer ball included

Bulk #	PKG#	Finish	GTW
CU 16085	--	powder coat	25,000



Universal Fifth Wheel Base Rails

- Drill Required

Part #	Description	Finish
CU16100	2 Universal 5th Wheel Base Rails (includes 16104 and 16101)	Gloss Black
CU16104	2 Universal 5th Wheel Base Rails ONLY (Brackets & Hardware Kits not included)	Gloss Black
CU16200	2 Universal 5th Wheel Base Rails (includes 16204 and 16101)	Carbide Black
CU16204	2 Universal 5th Wheel Base Rails ONLY (Brackets & Hardware Kits not included)	Carbide Black
CU16101	Universal 5th Wheel Rail Mounting Hardware Kit. Universal brackets and hardware included.	



CURT SPIDER GOOSENECK



Hardware kit included



C-113



Fixed Ball Gooseneck Hitch

- 30,000 lb. GTW flat plate
- Safety chain hook-ups sold separately
- All the heavy duty features as our popular C-52 except for folding capabilities
- Installs easily by being able to use our underbed Folding Ball Hitch Assembly Kits for a more secure fit
- **NOTE:** Underbed reinforcement required to reach maximum GTW rating. Use CURT Folding Ball assembly kits, page 69

Bulk #	PKG #	Finish	GTW	Description
CU C-10	--	powder coat	30,000	Fixed Ball Gooseneck Hitch
CUC-113	--	n/a	n/a	U-Bolt Replacement Kit for C-10



Gooseneck Bent Hitch Plate

- For the sole purpose of towing gooseneck trailers
- Heavy Duty 1/4" bent plate assembly
- 1 1/4" hole trailer ball
- Order safety chain U-bolts using part # CUC-113

Ball is not included. Recommended ball part# A-41

Bulk #	PKG #	Finish	GTW	Description
CUC-53	--	raw	25,000	Hitch plate, 2 1/2" tall x 18 1/4" x 48" w/ 1 1/4" hole
CUC-54	--	powder coat	25,000	Hitch plate, 2 1/2" tall x 18 1/4" x 48" w/ 1 1/4" hole
CUC-113**	--	n/a	n/a	Safety Chain U-Bolt Kit for use w/ CUC-53 & CUC54
CUC-41	--	raw	30,000	Hitch ball, 2 5/16" x 1 1/4" x 2 1/4"



CUC-113

**CUC-113 sold separately While supplies last



Gooseneck Flat Plate

- The only ready-to-install flat plate
- Comes complete with a 30,000 lb. chrome ball and 1/2" D-rings
- **NOTE:** Underbed reinforcement required to reach maximum GTW rating. Use CURT Folding Ball assembly kits

Bulk #	PKG #	Finish	GTW	Description
CUC-55	--	powder coat	30,000	Hitch plate, 13" x 46" w/ two 1/2" welded, forged D-Rings 30,000 GTW, 2 5/16" Trailer ball included

* = Special Order/Non-stock







C



Easier Hitching And Unhitching On Uneven Ground
 A Simple Turn Of The handle Allows For Swivel Or Non-Swivel
 Towing Tested To Include A 50% (at 16,000lbs) Safety Factor
 Four height Adjustments
 Bed Rail And Universal mounting Brackets Are Included.
 Attractive powder Coat Finish
 May fit other brand rails if needed

15500

NOTE: DOES NOT WORK WITH '03 - PRESENT DODGE WITHOUT USE OF 50062 MOUNT KIT NOT INCLUDED

Image		Part Number	Description
		15550	Rail kit with hardware - Universal L brackets
		TTFWH	Tuff Tow 5th wheel handle
		TTFIK	Tuff Tow Fifth Wheel Installation Kit 2 Long Brackets, 2 Short Brackets with Mounting Hardware
		TTFWSK	Tuff Tow Fifth Wheel Spring Kit 1 Large Spring, 1 Small Spring
		TTFWBK	Tuff Tow Fifth Wheel Bolt Package Cross Member 4 Bolts, 4 Nuts, 2 Head Pins with Clips, 4 Rail Pins with Clips (No Rail Bracket Mount Bolts)
		TTFWPK	Tuff Tow Fifth Wheel Mount Pink Kit 4 Rail Pins & Clips, 2 Cradle Pins
		TTSBM	Tuff Tow Short Bed Maximizer Rail included

C

TUFF TOW HITCHES



SIGNATURE SERIES® FIFTH WHEELS

16K SIGNATURE SERIES®

- 16,000 lbs. gross / 4,000 pin weight capacities
- 2 way (front to back) 10° head pivot

PRE ASSEMBLED 18K With Or Without SLIDER

- 18,000 lbs. gross / 4,500 pin weight capacities
- Improved 4 way head pivot
- 4° side to side head pivot for better control
- 14" – 18" vertical adjustment
- Forged single jaw
- Increased kingpin/jaw contact design
- Self latching jaw design
- King pin indicator
- Wider footprint for increased stability
- Stamped rounded head
- Wider 9" (vs 6") kingpin funnel area on head
- Vehicle specific under bed mounting kits
- Lockable handle (lock sold separately)
- 1/4" turn handle "quick lock" mount system
- Non-pin mounting reduces slop
- Contemporary 21st century appearance
- New folding tab washers for easy of installation
- 7 year limited warranty

- Extended length handle
 - Pre-Assembled Fifth Wheel units
 - Saves approximately one hour of assembly time
 - Foot assembly is hand tightened
 - Includes wrench to tighten foot assembly
 - Shipped in one convenient carton

NEW !!

24K SIGNATURE SERIES®

- All 18K features except Pre-Assembled, plus:
- 24,000 lbs. gross / 6,000 pin weight capacities
- Reinforced head
- Heavier forged jaw
- Higher capacity head support structure



Signature Series®



SIGNATURE SERIES® FIFTH WHEEL HITCH

Part No.	Description	Reese#
40847	18K Signature Series® - Pre Assembled	30847
40285	18K Signature Series® with Slider - Pre Assembled	30085
40259	24K Signature Series®	30059

Note: Will not fit trucks with beds shorter than 6' in length or with Flairside/ Stepside

SIGNATURE SERIES® SLIDER

Designed for short bed and extended cab short bed pickups to provide additional turning clearance and to prevent damage to truck and trailer in tight locations at low speeds.

- 10" Travel
- Fits both 16K and 18K Signature Series® Fifth Wheels
- Round rail design allows for smoother operation
- Operation from either side of unit (handle can be mounted on either side)
- Angled steel rollers reduces binding
- Operates even when vehicle not in straight line
- Operation up to 45° angle.
- Lock Pin for additional security
- Rubber grip handle for comfortable operation
- The vertical adjustment is limited to 16" - 18"



Part No.	Description	Price
40270	Signature Series® Slider, for use with the 16K & 18K Signature Series® Fifth Wheels only	

Reese# 30072

† - Available while supplies last



40845
Reese# 30845

For use with Draw-Tite
Signature Series® rail kits only

SIGNATURE SERIES® GOOSENECK

- Rated for 30,000 lbs. capacity
- Specifically designed for the Professional Tower who employs both 5th Wheel and Gooseneck trailers
- Utilizes the same vehicle specific under-bed rail kit system as the Signature Series® 5th Wheel
- Above-Bed Gooseneck can be easily removed for unobstructed use of the truck bed
- "Power Puck" receptacle system provides for easy installation and securing of Gooseneck
- 2 3/8" forged, heat treated ball
- Futuristic design and appearance
- Four point attachment to truck bed for added strength
- Utilizes wider footprint for increased stability
- Weather resistant plastic covering provides protection from the elements and aesthetic appeal
- Built in Chain Bracket to accommodate safety chain

Part No.	Description	Reese#
40845*	Signature Series® Gooseneck	30845

*Will not fit trucks with beds shorter than 6' in length

SIGNATURE SERIES® RAIL KITS

Signature Series® Rail Kits are designed for use with the Signature Series® Systems only.

- "Power Puck" mounting system provides uninhibited use of truck bed when Fifth Wheel or Gooseneck is dismounted
- Wider platform/mounting footprint (increased stability)
- Custom-fit under-bed mounting system.
- Machined platform receptacles
- Black powder coat finish



Make	Years	Model	Part #
Chevrolet/GMC	88-00	Old Body Style, 6' & 8' Beds Except Stepside	30063
	99-06	1500/2500, 6' Bed Except Stepside	30061
	2007	Classic 1500/2500, 6' Bed	30061
	99-06	1500/2500, 8' Bed	30060
	2007	Classic 1500/2500, 8' Bed	30060
	01-06	2500 HD, 8' Bed	30082
	2007	2500 HD Classic, 8' Bed	30082
	01-06	3500, 8' Bed	30062†
	2007	Classic 3500, 8' Bed	30062†
	01-06	3500, 8' Bed	30082
	2007	Classic 3500 Series	30082
	Dodge	94-01	1500/2500/3500, 6' & 8' Beds
2002		2500, 6' & 8' Beds	30069
2002		3500, 8' Bed	30069
02-07		1500, 6' & 8' Beds Excluding Mega Cab	30067†
03-07		2500HD, 6' & 8' Beds Excluding Mega Cab	30067†
03-07		3500HD, 8' Bed Excluding Mega Cab	30067†
02-07		1500, 6' & 8' Beds Including Mega Cab "NO DRILL" Accessory Kit included	30074
03-07		2500HD, 6' & 8' Beds Including Mega Cab "NO DRILL" Accessory Kit included	30074
03-07		3500HD, 6' & 8' Bed Incl. Mega Cab & Dually "NO DRILL" Accessory Kit included	30074
Ford		97-03	F-150, 6' & 8' Beds Except Flareside
	2004	F-150 Heritage (Old Body Style), 6' & 8' Beds Except Flareside	30065
	04-07	F-150, 6' & 8' Beds Except Flareside	30064
	97-99	F-250 LD, 6' & 8' Beds	30065
	WSL	99-04	F-250/F-350 Super Duty (Except Cab & Chassis, Diesel)
99-04		F-250/F-350 Super Duty Diesel, V10	30073
05-08		F-250/F-350 Super Duty (Except Cab & Chassis)	30073
Toyota	00-06	Tundra w/ Reg. Cab - Long Bed Only	30078
Commercial Trucks		All	30068

* Will not fit trucks with beds shorter than 6' in length or Flareside / Stepside

Reese# 83001
40001



SIGNATURE SERIES® LUBE PLATE

Nylon Lube Plate Protects Fifth Wheel Plate from the Wear of Normal Towing

- Large, 12" Surface for Extra Protection
- Eliminates the Need for Messy Grease

Part No.	Description	Price
40001	12" Lube Plate for use with Signature Series® Fifth Wheel Hitches Only	

Reese# 83001

† - Available while supplies last

THE FIFTH WHEEL YOU KNOW, BUT BETTER!

NEW !!



Features our Signature Series® head, with the base & mounting kit that you already know & love from our Select Series line of Fifth Wheel hitches!

The above bed rail system uses the popular universal mounting kit #30035 (sold separately) or the NEW vehicle specific custom quick install kits which reduce install time by up to fifty percent.

18K SELECT PLUS™ FIFTH WHEEL

- 18,000 lbs. gross, 4,500 lbs. pin weight capacities
- 14" to 18" vertical height adjustment
- Features Signature Series™ head....
 - Tough, heavy-duty stamped head—looks just like the ones on the real tractor-trailers!
 - 4 way (front & back/side-to-side) head pivot
 - 6° side-to-side head pivot
 - Kingpin indicator
 - Increased kingpin contact design
 - Wider 9" (vs. 6") kingpin funnel area
 - Forged single jaw
 - Self latching jaw design
- 5-year limited warranty

18K SELECT PLUS™ FIFTH WHEEL



Reese# 30081

18K SELECT PLUS™ FIFTH WHEEL

Offered with Square Tube Slider



Reese# 30082

18K SELECT PLUS™ FIFTH WHEEL

Offered with Round Tube Slider



Reese# 30083

Part No.	Description	Reese#
40261	18K Select Plus Series™	Reese# 30081
40163	18K Select Plus Series™ with Round Tube Slider	Reese# 30082
40164	18K Select Plus Series™ with Square Tube Slider	Reese# 30083



15K WSL

Shown with Base Rails (Sold Separately)

Also available with square tube slider (kit part #6031)

SELECT SERIES 15K FIFTH WHEEL

Quick-easy installation, strong, reliable performance and easy removal in seconds allows full access to the truck bed for maximum versatility.

- Two-jaw locking system
- Fore-and-aft pivot
- Locking Jaw handle
- Vertically adjusts from 12½" to 16½"
- 15,000 lbs. towing capacity
- 3,750 lbs. pin weight capacity
- Wide stance one-piece legs for improved stability
- Requires Rails & Installation Kit (sold separately)
- 5 year limited warranty

Part No	Description	Capacity	Pin Capacity	Adjustment Heights	
6030*	15K 5th Wheel Hitch	15,000 lbs.	3,750 lbs.	12½" to 16½"	WSL
6031*	15K 5th Wheel Hitch with Square Slider Unit	15,000 lbs.	3,750 lbs.	13" to 17"	WSL

Rails And Installation Kit Must Be Ordered Separately (#30035).

* Will not fit trucks with beds shorter than 6' in length or Flareside / Stepside



16K

Shown with Base Rails (Sold Separately)

Also available with Round Tube Slider (kit #40119) or Square Tube Slider (kit #6033)

SELECT SERIES 16K FIFTH WHEEL

Featuring side-to-side pivot action to better accommodate hook-ups on uneven ground. Quick-easy installation, strong performance and easy removal in just seconds to allow full access to the truck bed.

- Two-jaw locking system
- Fore-and-aft and side-to-side 4"-5" pivot
- Locking jaw handle
- Vertically adjusts from 14½" to 18"
- 16,000 lbs. towing capacity
- 4,000 lbs. pin weight capacity
- Wide stance one-piece legs for improved stability
- Requires Rails & Installation Kit (sold separately)
- 5 year limited warranty

Part No	Description	Capacity	Pin Capacity	Adjustment Heights	Reese#
6032*	16K 5th Wheel Hitch	16,000 lbs.	4,000 lbs.	14½" to 18"	30047
6033*	16K 5th Wheel Hitch with Square Tube Slider	16,000 lbs.	4,000 lbs.	15" to 18"	30051
40119*	16K 5th Wheel Hitch w/Round Tube Slider				30075

6010 Pivot Head lockout for Select Series 16K Fifth Wheels

Rails And Installation Kit Must Be Ordered Separately (#30035).

* Will not fit trucks with beds shorter than 6' in length or Flareside / Stepside



6010



6011 Slick Disc 10"



20K

6021

Shown with Base Rails (Sold Separately)

SELECT SERIES 20K FIFTH WHEEL

Features side-to-side pivot to better accommodate hook-ups on uneven ground. Quick installation, strong, reliable performance and easy removal to allow full truck bed access.

- Two-jaw locking system
- Fore-and-aft and side-to-side pivot
- Locking jaw handle
- Vertically adjusts from 14½" to 18½"
- 20,000 lbs. towing capacity
- 5,000 lbs. pin weight capacity
- Solid base assembly for superior stability
- Requires Rails & Installation Kit (sold separately)
- 5 year limited warranty

Part No	Description	Capacity	Pin Capacity	Adjustment Heights	Price
6021*	20K 5th Wheel Hitch	20,000 lbs.	5,000 lbs.	14½" to 18½"	

Rails And Installation Kit Must Be Ordered Separately (#30035).

* Will not fit trucks with beds shorter than 6' in length or Flareside / Stepside

Reese# 30033

* = Special Order/Non-stock

C

DRAW-TITE 5TH WHEEL HITCHES

SELECT SERIES 22K FIFTH WHEEL

Same great features as other Fifth Wheel Hitches, with the capacity to haul the heaviest loads.

- Two-jaw locking system
- Fore-and-aft pivot
- Locking jaw handle
- Vertically adjusts from 13¼" to 17¼"
- 22,000 lbs. towing capacity
- 5,500 lbs. pin weight capacity
- Solid base assembly for superior stability
- Requires Rails & Installation Kit (sold separately)
- 5 year limited warranty

WSL

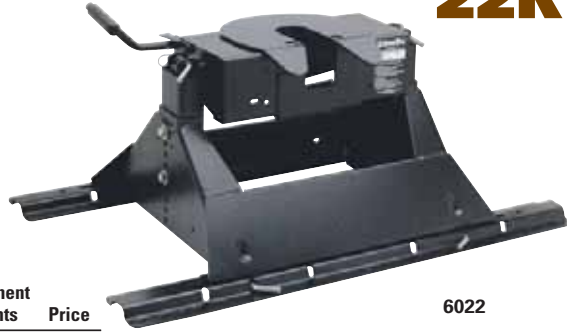

22K

6022

Shown with Base Rails
(Sold Separately)

Part No	Description	Capacity	Pin Capacity	Adjustment Heights	Price
6022*	22K 5th Wheel Hitch	22,000 lbs.	5,500 lbs.	13¼" to 17¼"	

Rails And Installation Kit Must Be Ordered Separately (#30035).

* Will not fit trucks with beds shorter than 6' in length or Flareside / Stepside

PRO SERIES™ FIFTH WHEEL

An economy Fifth Wheel Hitch that doesn't act like one. The Pro Series™ offers features only found in larger units. Installs and removes easily for full bed access.

- Rounded Slide Bar jaw mechanism designed for automatic latching with cushion grip handle
- 4-way pivoting head
- Skid plate pivots 5° side-to-side for easier hookup on uneven ground and smoother towing
- Jaw handle with tab for optional padlock security (padlock not included)
- Vertically adjusts from 13" to 17" to best match-up with different trailers
- 15,000 lbs. towing capacity
- 3,750 lbs. pin weight capacity
- Wide stance one-piece legs for improved stability
- Includes #30035 base rail kit
- 3 year limited warranty

NEW PART NUMBER!



15K

30056

AVAILABLE IN SKID QUANTITIES OF 16. (EXAMPLE: 30056-016)

Part No	Old No	Description	Capacity	Pin Capacity	Adjustment Heights	Price
30056*	7168†*	Pro Series™ 5th Wheel Hitch	15,000 lbs.	3,750 lbs.	13" to 17"	

* Will not fit trucks with beds shorter than 6' in length or Flareside / Stepside

PRO SERIES™ FIFTH WHEEL WITH SQUARE TUBE SLIDER

Designed for shortbed trucks to provide clearance and prevent damage to truck and trailer in tight spaces at slow speeds

- 10" travel front to back
- Adjustable with trailer attached
- Can be used with full size or mini trucks
- Compatible with any above bed rail kit
- Rounded Slide Bar jaw mechanism designed for automatic latching with cushion grip handle
- 4-way pivoting head
- Skid plate pivots 5° side-to-side for easier hookup on uneven ground and smoother towing
- Jaw handle with tab for optional padlock security (padlock not included)
- Vertically adjusts from 13" to 17" to best match-up with different trailers
- 15,000 lbs. towing capacity
- 3,750 lbs. pin weight capacity
- Wide stance one-piece legs for improved stability
- Includes #30035 base rail kit
- 3 year limited warranty

NEW PART NUMBER!



15K

30076

AVAILABLE IN SKID QUANTITIES OF 18. (EXAMPLE: 30076-018)

Part No	Old No	Description	Price
30076	40476†*	Pro Series™ 5th Wheel with Square Tube Slider	

* Will not fit trucks with beds shorter than 6' in length or Flareside / Stepside

† - Available while supplies last

FIFTH WHEEL HITCHES



ROUND TUBE SLIDER

Designed for short bed trucks and extended cab short bed pickups to provide additional turning clearance and to prevent damage to truck and trailer in tight locations at low speeds. Fits both 15K and 16K Select Series & 18K Select Plus Fifth Wheel Hitches.



50008

Requires #30035 universal base rail kit (sold separately)

- Designed for Pro Series™, 15K, and 16K Select Series models including Select Plus
- 12" travel front to back
- Round tube design allows for smoother operation
- Operation from either side of unit
- Angled steel rollers reduces binding
- Operates even when vehicle not in straight line
- Operation up to 45° angle
- Lock pin for additional security
- Rubber grip handle for comfortable operation
- Tapered holes for easier pull pin engagement
- 3" wide attachment allows for use with other 5th wheel hitches
- Uses existing base rail design
- For use with short box pick-ups. Prevents damage to cab when spotting trailer. Rails and installation kit sold separately, see below.
- Minimum 13" extended trailer pin box recommended

Part No	Description	Price
50008	Slider Round Tube Kit for 15K & 16K Select Series, plus 18K Select Plus™ 5th Wheel Hitches	

Rails And Installation Kit Must Be Ordered Separately (#30035).

Note: Check clearance between king pin bed and tailgate before moving to maneuvering position

Note: Will not fit trucks with beds shorter than 6' in length or Flareside / Stepside

SQUARE TUBE SLIDER

Designed for short bed trucks and extended cab short bed pickups to provide additional turning clearance and to prevent damage to truck when spotting trailer. Fits Pro Series™, 15K and 16K Select Series & 18K Select Plus Fifth Wheel Hitches.



30048

Requires #30035 universal base rail kit (sold separately)

- 6 roller design
- 10" travel fore-and-aft
- Works with full size and downsize mini trucks
- Fully adjustable with trailer attached
- Minimum 13" extended trailer pin box recommended
- Requires #30035 Universal Base Rail Kit (sold separately)

Part No	Description	Price
30048	Slider Square Tube Kit for 15K & 16K Select Series, plus 18K Select Plus™ 5th Wheel Hitches	

Rails And Installation Kit Must Be Ordered Separately (#30035).

Note: Check clearance between king pin bed and tailgate before moving to maneuvering position

Note: Will not fit trucks with beds shorter than 6' in length or Flareside / Stepside

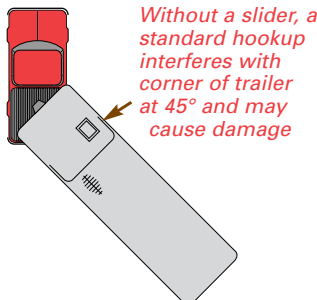

Without a slider, a standard hookup interferes with corner of trailer at 45° and may cause damage

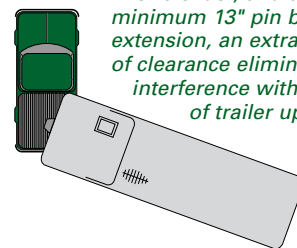

With a slider, and a minimum 13" pin box extension, an extra 10" of clearance eliminates interference with corner of trailer up to 80°

* = Special Order/Non-stock

C



30079

REMOTE SLIDER ACTUATOR FOR KWIK-SLIDE™



- Adds convenience for fifth wheel users! No more getting out of the cab to lock & unlock the Kwik-Slide™ slider. Allows complete slider operation from the driver's seat!
- Lighted indicators on the remote show the driver when fifth wheel is ready for safe maneuvering or towing:
 - Blue = Locked for Maneuver
 - Yellow = Maneuvering
 - Green = Travel position
- Warning "signal" to alert bystanders of trailer movement
- Fits all Kwik-Slide fifth wheel slider units!
- 5 year limited warranty



Part No.	Description
30079	Remote Slider Actuator for Kwik-Slide™ Slider

30K FIFTH WHEEL LOW PROFILE HITCH



- Low profile design can be vertically adjusted 3" to permit level trailering (9-1/2" to 12-1/2") above vehicle deck
- Side-tilt design reduces vehicle frame stress, creating a smoother, more comfortable ride and making hook-up and un-hook much easier
- Specially designed and engineered for the serious tower, primarily on medium-duty conversion trucks
- Actuating handle is more easily accessible than most fifth wheels, making hook-up quicker and more convenient
- 30,000 lbs. capacity; 7,500 lbs. pin weight capacity
- 5 year limited warranty

Part No.	Description
30054	30K Fifth Wheel Complete Base rails not used with this model. Mounts directly to medium-duty truck

Note: Will not fit trucks with beds shorter than 6' in length unless used with Sidewinder, see page 318. Will not fit trucks with flareside/ stepside.

Non Removable

C

REESE 5TH WHEEL

C

HEAVY DUTY TOWING



20K Q5 Fifth Wheel

- Spherical axial bearing ensures smooth, quiet towing
- Positive locking dual jaw system with 360° pin contact and lock indicators for peace of mind
- Short throw single handle operation
- Mounts to industry standard rails (Part Number 16200 sold separately)
- Jaw pins made of 1" Alloy Steel
- Self-aligning head for easy hookups
- 3 point progressive resistance limits lateral movement 7"
- 2 pin head removal
- 3 lube points w/ easy access grease fitting
- Lockable for trailer security
- Meets or exceeds current & proposed industry standards
- Carbide Black Finish
- U.S. Patent # 6,935,650 & other patents pending

10 YEAR WARRANTY

Part #	Description	Capacity	Height
CU 16125	Q5 Fifth Wheel	20,000 lb.	13"-17"
CU 16126	Q5 Fifth Wheel with rails	20,000 lb.	13"-17"
CU 16525	Q5 Fifth Wheel Head Unit (For use with the 16500 R5 Roller)	20,000 lb.	--
CU 16526	Q5 Fifth Wheel (16525) with R5 Roller (16500)	20,000 lb.	17½"-21½"
CU 16626	Q5 Fifth Wheel (16525) with R5 Roller (16500) and Base Rails (16200)	20,000 lb.	17½"-21½"



Q5 Replacement Parts Available!



Q5 - Three Point Indicator System

- Visible from inside your truck.
- Read Instruction Sheet "PA2 - Coupling - Uncoupling - Removal - Re-Installation" before operating.



RED - UNCOUPLE - Jaws locked open. Indicates it is safe to pull your truck away from the trailer. **Do Not Couple!**

YELLOW - COUPLE - Jaws ready to Couple. Indicates it is safe to back your truck in for coupling to your trailer.

GREEN - TOW - Jaws locked closed. Two locations that indicate it is safe to tow your trailer.

(Visibly inspect hitch to make sure proper coupling has been engaged)

ALWAYS USE SAFETY LATCH & PIN



16K E5 Fifth Wheel

- 16K Towing Capacity
- Single handle operation
- Auto locking mechanism
- Dual pivot head
- 4 position height adjustment
- Head removal 2 pins
- Entire unit 4 pins
- 10° lateral movement
- Anti-rattle skid plate
- Permalube pivot bushings
- Industry standard rail configuration
- Meets or exceeds current & proposed industry standards
- 5 YEAR WARRANTY

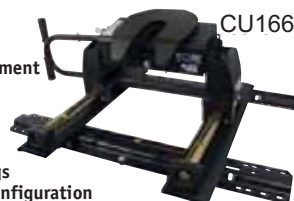

Part #	Description	Capacity	Height
CU 16115	E5 Fifth Wheel	16,000 lb.	13¼"-17"
CU 16116	E5 Fifth Wheel with rails	16,000 lb.	13¼"-17"
CU 16515	E5 Fifth Wheel Head Unit (For use with the 16500 R5 Roller)	16,000 lb.	--
CU 16516	E5 Fifth Wheel (16515) with R5 Roller (16500)	16,000 lb.	14"-17"
CU 16616	E5 Fifth Wheel (16515) with R5 Roller (16500) and Base Rails (16200)	16,000 lb.	14"-17"



CU 16115 with packaging

20K R5 Fifth Wheel Roller

- Up to 20,000 lb. Tow Rating
- Carbide Black Finish
- Non-binding Rod-Guide feature
- Self-locking
- True Rolling Unit
- Accommodates both Q5 (16525) and E5 (16515) head units
- Call for fit information for other manufacturers head units
- Patents Pending
- 7 Year Warranty



CU16500

Part #	Description	Capacity
CU16500	R5 Fifth Wheel Roller	up to 20,000 lbs

Universal Fifth Wheel Base Rails

- Drill Required

Part #	Description	Finish
CU16100	2 Universal 5th Wheel Base Rails (includes 16104 and 16101)	Gloss Black
CU16104	2 Universal 5th Wheel Base Rails ONLY (Brackets & Hardware Kits not included)	Gloss Black
CU16200	2 Universal 5th Wheel Base Rails (includes 16204 and 16101)	Carbide Black
CU16204	2 Universal 5th Wheel Base Rails ONLY (Brackets & Hardware Kits not included)	Carbide Black
CU16101	Universal 5th Wheel Rail Mounting Hardware Kit. Universal brackets and hardware included.	



CU 16104
gloss black

CU16101

Custom Fifth Wheel Bracket Kits

- Use with Universal 5th Wheel Base Rails (listed above)
- Hardware included

Item	Application	Years	Style	Notes	Req/Opt	Rail Part Needed	
						Carbide	Gloss
CU16412	Chevy/GMC 1500 New Body	2007-2008	A	Ø	Optional	CU16204	16104
CU16418	Chevy/GMC 1500 Classic	1999-2007	A	Drill	Optional	CU16204	16104
CU16418	Chevy/GMC 2500 & 3500 New & Classic	2001-2008	A	Drill	Optional	CU16204	16104
CU16419	Dodge Ram 1500, 6' & 8' Box	2002-2006	A	Ø	Optional	CU16204	16104
CU16303	Dodge 1500	2002-2008	B	Drill	Required	CU16200	16100
CU16419	Dodge Ram 2500, 6' & 8' Box	2003-2006	A	Ø	Optional	CU16204	16104
CU16301	Dodge 2500 & 3500	2003-2008	B	Drill	Required	CU16200	16100
CU16441	Ford F-150, 6' & 8' Box	2004-2008	A	Ø	Optional	CU16204	16104
CU16300	Ford F-150	2004-2008	B	Drill	Required	CU16200	16100
CU16437	Ford F-150 Heritage	2004	A	Drill	Optional	CU16204	16104
CU16437	Ford F-150	1997-2003	A	Ø	Optional	CU16204	16104
CU16447	Ford F-250 & F-350 6' & 8' Box	2005-2008	A	Drill	Optional	CU16204	16104
CU16447	Ford F-450 SD, 6' & 8' Box	2008	A	Drill	Optional	CU16204	16104
CU16443	Ford F-250 & F-350 S.D	1999-2004	A	Drill	Optional	CU16204	16104
CU16437	Ford F-250 LD	1997-2003	A	Drill	Optional	CU16204	16104
CU16468	Toyota Tundra	2007	A	Drill	Optional	CU16204	16104
CU16465	Toyota Tundra, Standard Cab, Long Box	2000-2006	A	Ø	Optional	CU16204	16104
CU16302	Toyota Tundra	2000-2006	B	Drill	Required	CU16200	16100

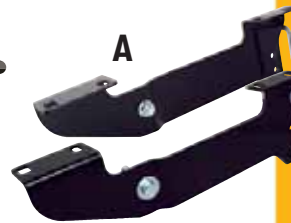

A



B

Fifth Wheel Lube Plate

- Protect your investment with our 10" lube plate. Reduce normal wear & tear when towing and eliminate messy grease deposits.

Bulk #	Pkg #	Description
CU16721	--	10" 5th Wheel Lube Plate



5th Wheel / Gooseneck Hitch Adapter Harnesses

- See Pages 80-83 for more detailed information

Make	Model	Years	Part#
CU 56000	CHEV/GMC SILVERADO/SIERRA (Classic w/Factory 7-way)	2007-2007	
	CHEV/GMC SILVERADO/SIERRA (New Body)	2007-2007	
	CHEV/GMC SILVERADO/SIERRA (w/Factory 7-way)	1999-2006	
CU 56000	FORD F-150 & F-250 LIGHT DUTY (w/Factory 7-way)	1997-2003	
	FORD F-150 (New Body Style w/Factory 7-way)	2004-2007	
	FORD F-150 HERITAGE (Old Body Style w/Factory 7-way)	2004-2004	
	FORD F-250 & F-350 SUPER DUTY (w/Factory 7-way)	1999-2007	
	FORD F-450 & F-550 SUPER DUTY (w/Factory 7-way)	1999-2007	
CU 56001	DODGE DAKOTA (w/Factory 7-way)	1995-2007	
	DODGE RAM 1500	1995-2007	
	DODGE RAM 2500/3500 (w/Factory 7-way)	1995-2007	



CU56001



CU56000

Blue Ox SwayPro



BXW1000 Sway Pro 1000 Lb
BXW1500 Sway Pro 1500 Lb

Features:

- Easy hook up & disconnect. Built-in sway control. Snap in spring bar design. Can not fall out.
- Four separate points of adjustable contact to control trailer sway.
- Durable gold zinc finish won't chip, rust, or corrode.
- Easy to operate bracket lock that automatically secures the tongue bracket into place and just as easily releases it with the simple push of a lock pin.
- Simple precise weight distribution adjustment.
- Tongue brackets utilize sway control loops which limit side-to-side trailer sway, but still provide for free movement during turns.
- Available for four tongue weights: **BXW0550** (550 lbs), ***BXW0750** (750 lbs), and **BXW1000** (1000 lbs) **BXW1500** (1500 lbs)

- BXR4200** BED SAVER FITS TUFF TOW /PROEAGLE, BROPHY/RBW LIL ROCKER/ROBINS
- BXR4101** BED SAVER DRAW-TITE / REESE 14K-15K &16K
- BXR4400** BED SAVER FITS VALLEY 16K
- BXR4401** BED SAVER FITS VALLEY 15K

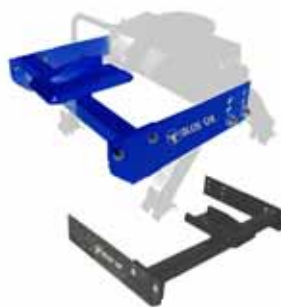

Safe, Worry Free Travel With The Bedsaver Fifth Wheel Safety System

Others available by special order

Dropping your fifth wheel is more common - and dangerous - than you might think. Just ask some of your RV friends that have experienced it.

You can put that worry to rest with the Bedsaver. This inexpensive, hassle-free safety device is a "must have" for every fifth wheel puller. With Bedsaver™, you can forget about dropping your fifth wheel - and forget about the potential danger, damage, expense, and embarrassment! The Bedsaver is a sound investment with great returns for all fifth wheel pullers.

- No moving parts. Bedsaver is always ready and requires little maintenance after installation
- Easy to install, requiring no drilling or hitch modification
- Hardware and instructions are included
- Trailer loads and unloads normally
- Black powder coated finish matches most hitches, blending so well it's difficult to tell it's even there
- Catches the pin and holds it SAFE AND SECURE



AVAILABLE BY SPECIAL ORDER ONLY

Pin Lock™ Fifth Wheel Safety System

Pin Lock™ adds an extra measure of safety to your fifth wheel. This simple device utilizes a counterweight door that folds down when you're loading the flaps up to lock the pin in place. This prevents the pin from accidentally disengaging. The only way to remove the pin is to raise it over the pin lock. Pin Lock™ is easy to install. Simply remove the front and back bolts that secure the top plate and replace the top plate with the Pin Lock™.

Louvered Tailgates



Saves 5% on your fuel while towing

Part Number	Description
<i>All 25 Series below are "Center Latch"</i>	
U2508FW	04-08 Ford F150 Only model 15769
U2510FW	87-96 Ford Pickup, 97-98 SuperDuty F250/350, 98-03 SuperCrew mdl 10482
U2511FW	2009 F150 Mdl 11954
U2519FW	99-07 Chevy: All Models, Will not fit with composite bed model 10483
U2520FW	88-99 Chevy: All Models, Some early 99's mdl 10485
U2531FW	94-01 Dodge Ram All Models, 02 2500/3500 Only model 10488
U2533FW	02 Dodge 1500 Only, 03-05 Dodge: All Models model 14214
U2534FW	TG CL 2334 DODGE 06-08 (ALL MODELS) 09 2500/3500 mdl 14966
U2507FW	FORD 2008 3/4 & 1 TON MODELS 99-09 sd 250/350 97-98 4dr L/D no supercrew model 10480 97-98 Light Duty, 99-03 All Models, 04-05 F250/350 SD
U2518FW	FW TAILGATE CHEVY 08-09 NEW body style only ALL MDLS will not fit w/composite box mdl 11967



Louvered Tailgate

Part Number	Description
UEG2409FW	97-98 Ford LightDuty, 99-03 All Models, 04 SuperDuty Only
UEG2410FW	97-99 Ford HeavyDuty
UEG2420FW	88-98 Chevrolet Classic Pickup
UEG2432FW	96-98 Dodge Ram Pickup

Hoppy

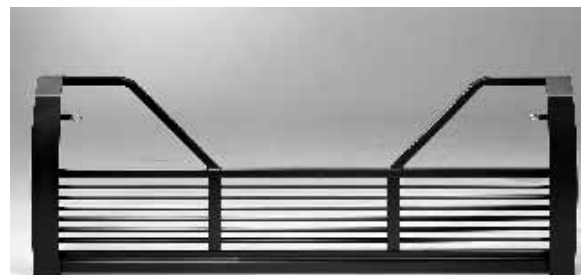

Econo Gate

LOUVERED TAILGATES

Tailgate EasyLift™

- Remove 80% of your tailgate's weight!
- Never struggle again to lift or lower your tailgate.
- Installs in 15 minutes.
- Manufactured of hardened spring steel.

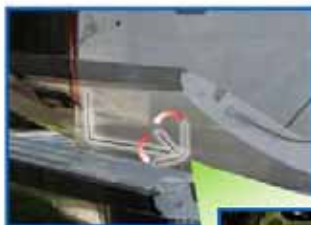

A torsion bar for your tailgate.



The Tailgate EasyLift does all the work. Open and close your tailgate with a single finger.



Now you can open and close your tailgate with a single finger!
The new Tailgate EasyLift by Hoppy removes 80% of your tailgate's weight and installs in about 15 minutes!
You'll never struggle again to lift or lower your tailgate!

EL1

Removes 80% of your tailgates weight
 Never Struggle again to lift or lower your tailgate
 A torsion bar for your tailgate
 Manufactured of hardened spring steel
 Installs in about 20 min.
 For use on most full size pickup trucks

One size fits the following trucks:

- Chevy/GMC Fullsize 1989-2005
- Dodge Ram 1994-2005
- Ford F-Series 1987-2005 (excludes f150 supercrew)
- Nissan Titan 2004-2005
- Toyota Tundra 2004-2005 Model 74211



Sway Control



TT340



TTSCP1 Square plate

TT340 - Friction Sway Control minimizes trailer sway. Right or Left hand control. Kit comes complete with all necessary hardware for installation.

TT3443 - 1 1/4" Ball Replacement



5/8" Hitch Pin & Clip



5/8RP

Combo Tubes

TTCT-6 - 6" x 2" Combo Tube Painted Black

TTCT-12 - 12" x 2" Combo Tube Painted Black



Ball Mounts

Rated 6,000 lbs

- TT2729** - 2" Drop 9" Long 3/4" Rise
- TT2739** - 2" Drop 10" Long 3/4" Rise
- TT2746** - 3 1/4" Drop 8 1/2" Long 2" Rise
- TT2766** - 3 1/4" Drop 12" Long 2" Rise
- TT2773** - 5 1/4" Drop 8 3/4" Long 4" Rise
- TT2786** - 6 1/2" Drop 9" Long 6 1/2" Rise
- TT2793** - 8" Drop 9 1/2" Long 6 1/2"
- TT2796** - 11" Drop 11 1/2" Long 8 1/2" Rise



TT2729

2" Drop Shanks

- TT4010** - WD Hitch bar 12" Length. 2 3/8 Drop
- TT4013** - Shank 12" Length, 5 5/8" Drop
- TT4014** - Shank 11" Length, 6 7/8" Drop
- TT4015** - Shank 11" Length, 8 3/4" Drop

2 1/2" Drop Shanks

- TT5013** - Shank 2 1/2" Dia, 12" Length, 5 5/8"
- TT5014** - Shank 2 1/2" Dia, 11" Length, 6 7/8"
- TT5015** - Shank 2 1/2" Dia, 11" Length, 8 3/4"



TT4013



TT5013

TUFF TOW SWAY CONTROL BALL MOUNTS & SHANKS

WEIGHT-DISTRIBUTING SYSTEMS

Add a Weight-Distributing System to provide a more level ride, greater steering and brake control.

THE DRAW-TITE DIFFERENCES are in construction materials, welding, manufacturing processes and hook-up. Adjustment is simple because of the easy-to-operate snap-up brackets that allow spring bar tension to be adjusted by changing links in the support chains. Rather than merely supporting the trailer tongue weight (TW), weight-distributing hitches apply leverage between the towing vehicle and trailer causing the TW to be carried by all axles of the tow vehicle and trailer.

A Draw-Tite Weight-Distributing Hitch System is composed of four major elements:

1. the hitch receiver,
2. the ball mount,
3. the spring bar assembly and,
4. the sway control (see below)

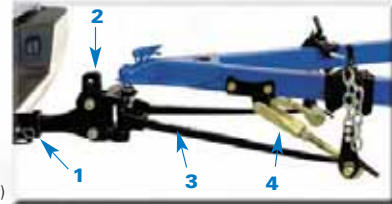

They work in unison to provide complete towing system compatibility.



WITHOUT WEIGHT-DISTRIBUTING HITCH



WITH WEIGHT-DISTRIBUTION



Dual Cam HP™ SWAY CONTROL

DRAW-TITE'S PREMIER SWAY CONTROL - Unlike the friction sway control, the Dual Cam HP™ has the ability to forestall sway from the start in addition to resisting sway once it's begun. Works only when needed and allows free and easy vehicle/trailer interaction. Installs on the trailer and therefore doesn't require adjustment every time the tow vehicle and trailer are hooked up, unless ball mount height angle or the number of working chain links are changed.

- Integrated cams into the spring bars reduce noise
- No U-bolts to conflict with bottle racks or other A-frame mounted items
- Specific attachment reference points provided
- Simple, easy adjustment of centerline
- Fits more applications
- Improved installation times
- Years of extensive field testing



STRAIT-LINE™ SYSTEM

This is the ultimate hitch in detail and by design. No other hitch gives the driver the control this one does at a reasonable price. The WD system consists of our patented Dual Cam High-Performance Sway Control and our High-Performance Weight-Distributing System in one easy-to-install package.

This WD system literally forces the trailer to stay in a straight line behind the tow vehicle. Sway is controlled by the Dual Cam High-Performance System. The stronger the sway force, the more the Dual Cam System works to stop it.

This system combines weight-distributing with the best proven pro-active sway control system available in a newly-designed, easy-to-install kit.

- Includes Dual Cam High Performance Sway Control and High Performance Weight Distributing Systems
- Simple installation and adjustment
- Fully automatic and self-centering
- Hooking up spring bars automatically hooks up sway control
- Reduced noise
- No U-bolts to conflict with bottle racks or other A-Frame mount items
- Specific attachment reference points provided
- Easy adjustment of centerline
- No need to relocate items on top of A-frame to install Dual Cam High-Performance Sway Control



40485
40486
40487

NEW !!

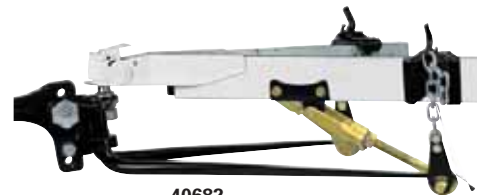

40682
40683
40684

STRAIT-LINE™ TRUNNION BAR WD KITS W/ SHANKS

Part No.	Qty.	Description	Reese #
40485	1	Strait-Line 600 (Includes 62540 & 26102)	66082
40486	1	Strait-Line 800 (Includes 62541 & 26102)	66083
40487	1	Strait-Line 1200 (Includes 62542 & 26102)	66084

Includes Weight Distribution Shank 63970

STRAIT-LINE™ ROUND BAR WD KITS W/ SHANKS

Part No.	Qty.	Description	Reese #
40682	1	Strait-Line 550 (Includes 62555 & 26102)	66086
40683	1	Strait-Line 750 (Includes 62556 & 26102)	66087
40684	1	Strait-Line 1000 (Includes 62557 & 26102)	66088

Includes Weight Distribution Shank 63970

SINGLE SPRING BAR WEIGHT-DISTRIBUTING HITCH KITS

This Light-Duty Weight-Distributing system is especially designed for use with lighter weight trailers and pop-up campers. The center mount single bar is contoured to avoid interference with center mounted jacks. Easy to set up and use. The lift mechanism is designed to prevent interference with gas bottles or battery trays. Works with any 2" receiver.

A-Frame trailers must have adequate mounting space for the cross-brace bracket. The cross-brace bracket must be mounted 18" to 26" rearward of the center of the coupler ball receptacle. Make sure the trailer is clear of any gas bottles, battery trays, or other obstructions within this area. See example below.

The integrated lifter bar feature provides the advantage of allowing a single person to operate this light duty kit from one side of the trailer. This system works with both side and center mounted tongue jacks. The sway control platform allows you to use a friction sway control on either side of the trailer.

- Bolt-On head with Weight-Distributing Shank
- Models for both A-Frame and Pole-Tongue trailers
- Rated up to 4,000/400 lbs. Weight-distributing
- Innovative single spring bar design
- Integral sway control platform
- Assembly hardware, and chains included
- Black powder coat finish

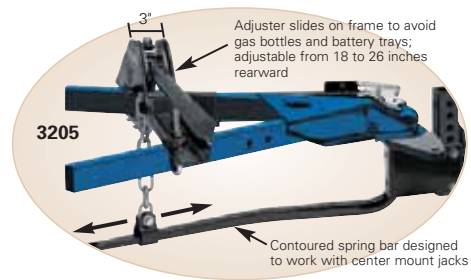

LIGHT-DUTY WEIGHT-DISTRIBUTING HITCHES

Part No.	Description	Maximum Rated Load Capacity		Reese #
		Tongue Wt.	Gross Trailer Wt.	
3204	Single Arm Weight-Distributing Hitch Kit for Pole-Tongue Trailers	400 lbs.	4,000 lbs.	66071
3205	Single Arm Weight-Distributing Hitch Kit for A-Frame Trailers	400 lbs.	4,000 lbs.	66069

*Note: Not recommended for use with surge brakes

Special Order

CLASS V TITAN WEIGHT-DISTRIBUTING HITCH SYSTEMS

Designed for loads beyond normal everyday towing situations: **TITAN**® Weight-Distributing Hitch Systems provide a trunnion-design with the highest rating available in the towing industry. Coupled with a 2½" Class V **TITAN**® receiver, heavy loads are transported with ease. Ideal for commercial and industrial use.

- Rated up to 12,000/1,200 lbs. weight carrying and 17,000/1,700 lbs. weight-distributing
- 2½" shank exclusively for use with **TITAN** receivers
- Elevated hitch ball platform provides superior coupler clearance
- Lift brackets designed to provide increased frame clearance
- Assembly hardware and chains included



CLASS V TITAN TRUNNION WEIGHT-DISTRIBUTING HITCH KIT

- Bolt together design
- Kit includes trunnion head, bars, chains & lift brackets.
- Shank and ball sold separately

Part No.	Qty.	Description	Price
66006	1	17,000 lbs. Trunnion Weight-Distributing Hitch Kit (Shank Not Included)	



CLASS V TITAN WEIGHT-DISTRIBUTING HITCH HEAD KIT

- Heavy duty 17,000 lbs. capacity
- Bolt-together design

Part No.	Qty.	Description	Price
58167	1	TOW BEAST ® Deluxe Trunnion Bolt-Together Head Kit (Includes Hardware)	



CLASS V TITAN WEIGHT-DISTRIBUTING SHANKS

- Heavy duty 17,000 lbs. capacity
- Bolt-together design

Part No.	Qty	Ratings (lbs.) GTW/TW	Shank Dia.	Length (A)	Drop (B)	Rise (C)	Price
54976	1	17,000/1,700	2½"	15"	1¼"	5¼"	
54977	1	17,000/1,700	2½"	15"	5¾"	8¼"	



POLE TONGUE ADAPTER

A Pole Tongue Adapter is used as a mounting platform for the Lift Brackets of a Weight-Distributing Hitch System when a trailer has a pole or straight tongue rather than an A-frame tongue.

- Fits all lift units regardless of manufacturer
- Fits tongue widths from 1½" to 5"
- Fits tongue heights from 3" to 6"

Part No.	Qty.	Description	Price
3280	1	Pole Tongue Adapter and Fasteners	
3360	1	Pole tongue Adapter and Fasteners	

NOTE: Not for use with 3205 light duty weight-distributing hitch

DRAW-TITE TRUNNION BAR WEIGHT-DISTRIBUTING HITCH SYSTEMS

Evolving to meet the changing requirements of the towing market, Draw-Tite Weight-Distributing Hitch Systems provide a softer ride and distribute load forces more evenly than ever before. The carrying capacity of these hitches is rated higher than most others in the marketplace, allowing consumers to tow heavy loads with confidence.

- Forged, bolt-together Trunnion style head
- Rated up to 6,000/600 lbs. weight carrying and 12,000/1,200 lbs. weight-distributing
- Available in 600, 800, and 1,200 lbs. tongue weight models
- 30" spring bars standard
- Integral dual platform supports left hand and dual sway control applications
- Elevated hitch ball platform provides superior coupler clearance
- Lift brackets designed to provide increased frame clearance
- Assembly hardware, and chains included
- Black powder coat finish
- Easy installation & hook-up
- No complicated adjustments or attachments
- Friction adjustment for multiple towing situations
- For use with all Class III & IV Hitches
- Shank sold separately

Part No.	Maximum Rated Load Capacity		Price
	Tongue Wt.	Gross Trailer Wt.	
7901	600 lbs.	12,000 lbs.	
7902	800 lbs.	12,000 lbs.	
7903	1,200 lbs.	12,000 lbs.	

REPLACEMENT PARTS

Part No.	Qty.	Description	Price
7979	1	Bolt Together Dual Ear Head Assembly & Fastener Package	
6662	2	Spring Bars (Bent), Trunnions (600 lbs.) Chains & Fasteners	
6664	2	Spring Bars (Bent), Trunnions (800 lbs.) Chains & Fasteners	
6666	2	Spring Bars (Bent), Trunnions (1,200 lbs.) Chains & Fasteners	
6637	2	Lift Unit Bracket Assembly	
21501	1	Lift Unit Bracket Assembly	

DRAW-TITE ROUND BAR WEIGHT-DISTRIBUTING HITCH SYSTEMS

Innovative in design, Draw-Tite Round Bar Weight-Distributing Hitch Systems present a strong design that is user friendly & promotes easy assembly & hook-up. The solid knuckle end of the one-piece spring bar offers a secure attachment that inhibits wear.

- Black powder coat finish
- Open head design allows easy tool access for Hitch Ball tightening
- Rated up to 5,000/500 lbs. weight carrying & 10,000/1,000 lbs. weight-distributing
- Available in 550, 750, & 1,000 lbs. tongue weight models
- 30" spring bars standard
- Built-in right hand sway control platform
- Elevated Hitch Ball platform provides superior coupler clearance
- Lift brackets designed to provide increased frame clearance
- Assembly hardware & chains included
- Easy installation & hook-up
- No complicated adjustments or attachments
- Friction adjustment for multiple towing situations
- For use with all Class III & IV Hitches
- Shank sold separately

Part No.	Maximum Rated Load Capacity		Price
	Tongue Wt.	Gross Trailer Wt.	
3201	550 lbs.	10,000 lbs.	
3202	750 lbs.	10,000 lbs.	
3203	1,000 lbs.	10,000 lbs.	

REPLACEMENT PARTS

Part No.	Qty.	Description	Price
3279	1	Bolt Together Head Assembly & Fastener Package	
3327	2	Spring Bars (Bent), Round Bar (600 lbs.) Chains & Fasteners	
3328	2	Spring Bars (Bent), Round Bar (800 lbs.) Chains & Fasteners	
3329	2	Spring Bars (Bent), Round Bar (1,200 lbs.) Chains & Fasteners	
6637	2	Lift Unit Bracket Assembly	
21501	1	Lift Unit Bracket Assembly	

Shown with optional friction sway control #3400, sold separately.



7901
7902
7903



Note: Replacement Parts Available

6662
6664
6666



Shown with optional Dual Cam HP sway control #26102, sold separately.



3201
3202
3203



3327
3328
3329



**PRO SERIES RB
(WEIGHT DIST. W/ ADJUSTABLE HITCH BAR)**

The innovative Pro Series™ RB weight distribution is engineered to provide the features you expect in a weight distribution kit at an economical price.

- Single piece cast head
- Easy to use adjusting washers
- Hex washer style allows for quick spring bar tension adjustment
- Compatible with Friction Sway Control (Passenger Side) (40660)
- Includes Shank 63970
- 5 Year Limited Warranty

**AVAILABLE IN SKID
QUANTITIES OF 25.
(EXAMPLE: 49575-025)**



Part No.	Maximum Rated Load Capacity		Price
	Tongue Wt.	Gross Trailer Wt.	
49575	550 lbs.	10,000 lbs.	
49576	750 lbs.	10,000 lbs.	
49577	1,000 lbs.	10,000 lbs.	

Includes Weight Distribution Shank 63970

NEW !!

**PRO SERIES SC
(WEIGHT DIST. W/ BUILT-IN SWAY CONTROL)**

We have combined the best features from our legendary Draw-Tite heavy-duty weight distributing kits & friction sway control to create Pro Series SC. From the proven Draw-Tite style head and adjustment system to the new innovative adjustable clamp on brackets with built-in sway control, the new Pro Series SC takes the integrated friction sway control concept to the next level. Unlike competitive units that don't provide enough friction to make much (if any) difference in sway resistance, our new Pro Series SC actually works to resist sway in all weather conditions! Best of all this system is fast to install, and affordable to all.



- Kits are available in 750/1100/1400 lbs.
- Well known, easily adjustable head using the proven Draw-Tite style serrated washer system
- Raised hitch ball platform
- New clamp on side brackets & adjustable pad hangers allow placement on the trailer frame without moving the gas bottles or batteries
- Integrated friction sway control - automotive friction material (used in vehicle brakes) has consistent, high friction control in all weather conditions
- Fast spring bar installation and removal after initial set-up
- Includes shank 63970
- 5 Year Limited Warranty



NEW !!

**AVAILABLE IN SKID
QUANTITIES OF 24.
(EXAMPLE: 49578-024)**



Part No.	Maximum Rated Load Capacity		Price
	Tongue Wt.	Gross Trailer Wt.	
* 49578	750 lbs.	14,000 lbs.	
49579	1,000 lbs.	14,000 lbs.	
49580	1,400 lbs.	14,000 lbs.	

Includes Weight Distribution Shank 63970

DRAW-TITE WEIGHT-DISTRIBUTING

Sold separately from the Weight-Distributing Hitch Kits, Draw-Tite Shanks offer a full range of style and adjustability. Designed for use with all Trunnion and Round Bar Weight Distributing Kits.

- Rated up to 1,400 lbs. tongue weight
- Angled, "T" and deep drop designs available
- Designed for use in the rise or drop position
- 2" x 2" solid shanks
- Black powder coat finish

Part No.	Style	Capacity Lbs. (TW)	Shank Bar Length (L1)	Length (L2)		Drop (D)		Rise (R)		Price
				Round	Trunnion	Round	Trunnion	Round	Trunnion	
3210	1	1,400	10"	12½"	11⅞"	2⅝"	1⅞"	5⅝"	6⅝"	
3211	2	1,400	11"	12½"	11⅞"	5⅝"	4⅞"	8⅞"	9⅞"	
3212	1	1,400	12"	14½"	13⅞"	2⅝"	1⅞"	5⅝"	6⅝"	
3213	2	1,400	12"	14½"	13⅞"	5⅝"	4⅞"	8⅞"	9⅞"	
3214	1	1,400	14"	16½"	15⅞"	2⅝"	1⅞"	5⅝"	6⅝"	
3215	2	1,400	11"	13½"	13⅞"	6⅞"	6⅞"	10⅞"	10⅞"	
3344	3	1,400	11"	13½"	12⅞"	8⅞"	8"	N/A	N/A	

NOTE: Above part numbers do not fit Draw-Tite adjustable ball mounts.

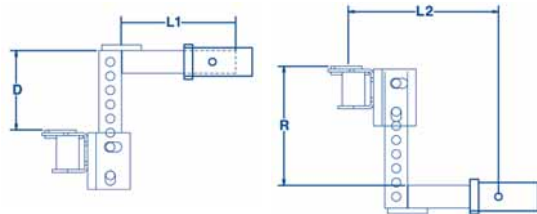

ADJUSTABLE SHANK

Part No.	Description	Total Ht Adj	Length (L)	Rise (R)	Drop (D)	Rating	Price
63970*	Adjustable Shank 2" sq (standard cast)	6¾"	13"	6"	1¼"	1,400/14,000	
54917	Adjustable shank 2" sq (standard cast)	16¼"	14"	10¼"	6"	1,200/12,000	

* Can only be used with Round Bar (62555, 62556, 62557) & Trunnion Bar (62540, 62541, 62542)

WEIGHT-DISTRIBUTING SNAP UP BRACKETS

- Rugged positive locking design
- Unit locks using safety pin (55180)
- Narrower, for increased frame clearance
- One-piece cast chain hook
- Black powder coat finish

Part No.	Qty.	Description	Price
6637	2	Lift Unit Bracket Assembly	
21501	1	Snap Up Bracket	
58162	1	Snap Up Handle	

NEW !!

WEIGHT-DISTRIBUTING CHAIN HANGERS

For trailers with tongue interference (gas bottles, batteries, covered frames, etc.) where Snap Up Brackets (#21501) won't install easily, we offer two easy-to-install options.

- Black Powder Coat Finish
- Install quickly! (approximately 15 minutes)
- Includes hardware

NEW !!

Part No.	Qty.	Description	Price
58305	1	Chain Hanger, Bolt On	
58306	1	Chain Hanger, Clamp On	

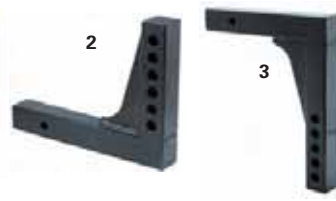

NEW !!



21501



58306



58305

SWAY CONTROLS

- Used to reduce trailer sway and improve handling in adverse towing conditions
- Sway control units dampen trailer sway caused by crosswinds and traffic
- Both friction and dual cam designs improve stability and increase towing safety

Dual Cam **HP**™

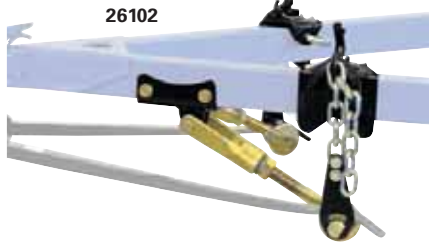

26102

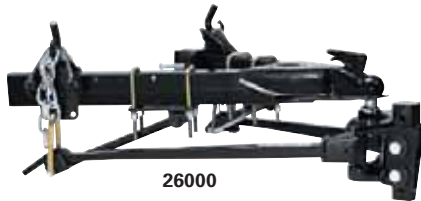

26000



3400



40660



3442



3443



3475



26003

26005

DUAL CAM HIGH PERFORMANCE SWAY CONTROL

- Integrated Cams into the Spring Bars Reduce Noise
- No U-bolts to Conflict with Bottle Racks or other A-frame mounted items
- Specific Attachment Reference Points Provided
- Simple, Easy Adjustment of Centerline
- Years of Extensive Field Testing
- Black Powder Coat Finish

Part No.	Qty.	Description	Price
26102*	1	Dual Cam High Performance Sway Control	

DUAL CAM SWAY CONTROLS

- Patented Cam design
- Fully automatic and self-centering
- Attaches directly to round or trunnion spring bars
- Bolts-on for easy installation
- Black powder coat finish

Part No.	Qty.	Description	Price
26000*	1	Dual Cam Sway Control Fits 4" & 5" Trailer Frames	
26001*	1	Dual Cam Sway Control Fits 6" Trailer Frames	
58091	2	10" U-Bolts Only (2 per Pkg)	

* Sway controls are to be used with Class III & IV Hitches only. Do not use on Class I Sportframe or Class II Frame Hitches. Cannot be used with surge brakes.

FRICTION SWAY CONTROLS

- Easy installation no complicated adjustments or attachments
- Friction adjustment for multiple towing situations
- Easy to hook-up
- For use with all Class III & IV Hitches
- Can be used on left and right side of trailer

Part No.	Qty.	Description	Price
3400	1	Sway Control Assembly and Fasteners - (Boxed)	
40660	1	Value Sway Control - (Boxed)	
3442	1	Weld-On Sway Control Adapter	
3443	1 Disp Pkg	Replacement Sway Control Ball 1 1/4" x 5/8"	

NOTE: Do not use on Class I Sportframe Hitches. Cannot be used with surge brakes. For trailers exceeding 26' use two friction sway controls or dual cam sway control

LEFT HAND ADAPTER FOR ROUND BAR WEIGHT-DISTRIBUTING HITCH HEADS

- Friction sway control applications when trailer components obstruct right-hand sway control attachment
- Easy bolt-on installation
- Bulk packaged
- Black powder coat finish

Part No.	Qty.	Description	Price
3475	1	Bolt-On Sway Control Adapter for Round Bar Heads (Left Side)	

Cannot be used with surge brakes. Will not fit Trunnion Bar or Round Bar weld-together.

BOLT-ON SWAY CONTROL ADAPTERS

- Bulk packaged
- Black powder coat finish

Part No.	Qty.	Description	Price
26003	1	Sway Control Adapter Bracket for Use With Class III & IV 2" Sq. Ball Mounts	
26005	1	Sway Control Adapter Bracket for Use With Class II 1 1/2" Sq. Drawbars Only	

NOTE: 26005 can not be used with Sportframe Drawbars. Ball platform does not prevent adapter from turning during tightening.

C

CURT Weight Distribution Hitches:

- Heavy duty Round Bar style and Trunnion style Weight Distribution Hitches
- Heavy duty adjustable formed head
- 2" x 2" adjustable hitch bar
- Forged solid steel spring bars
- Hook up brackets
- Durable powder coat finish resists rust & corrosion

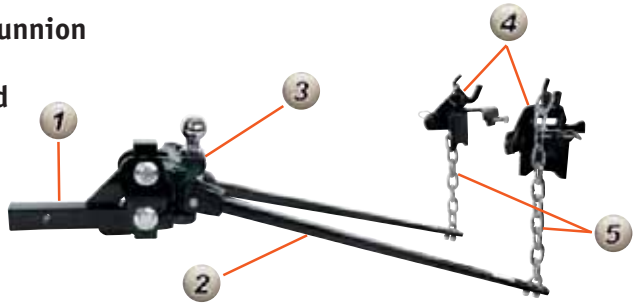

What is included with a Weight Distribution Hitch

- 1 Adjustable Weight Distribution Shank
- 2 Spring Bars
- 3 Adjustable Ball Mount
- 4 Hook-up Brackets
- 5 Hook-up Chains
- 6 Pin & Clip included

Note: Weight Distribution Hitches **DO NOT** include hitch ball
Recommend 2 5/16" A-6 or 2" A-90 Trailer Ball
See page 52

THE FUNCTION OF A WEIGHT DISTRIBUTION HITCH

Provides better control of your vehicle and trailer by applying leverage across the trailer tongue and tow vehicle for heavier loads to be distributed more evenly on the trailer wheels and tow vehicle. This even distribution allows for a more stable ride and better control for braking and steering.

Round Bar Weight Distribution Hitch



Part #	Description	Max tongue wt.	Max GTW
CU17000	Round Bar bolt-together wt. dist. kit shank included, 12" hitch bar	600	10,000
CU17001	Round Bar bolt-together wt. dist. kit shank included, 12" hitch bar	800	10,000
CU 17002	Round Bar bolt-together wt. dist. kit shank included, 12" hitch bar	1,000	10,000

Trunnion Style Weight Distribution Hitch



Part #	Description	Max tongue wt.	Max GTW
CU7300	Trunnion Bar bolt-together wt. dist. kit shank included, 12" hitch bar	600	10,000
CU17301	Trunnion Bar bolt-together wt. dist. kit shank included, 12" hitch bar	800	10,000
CU 17302	Trunnion Bar bolt-together wt. dist. kit shank included, 12" hitch bar	1,000	10,000

Sway Control

Reduces the lateral movements of the trailer caused by the wind



Part # Description

CU17200	Sway Control Kit Includes: 1) Sway control unit 2) Trailer mounted attachment ball w/hardware 3) Hitch mounted attachment ball (A-93) 4) Weld-on tab to adapt for left-hand use or for use without weight distribution hitch 5) Mount reinforcement plate 6) Attachment clips
CU A-93	Sway control hitch ball
CU 17201	Trailer mounted attachment ball



Weight Distribution Replacement Parts

Part #	Description	Length	Drop	Rise
1 ADJUSTABLE WEIGHT DISTRIBUTION SHANKS				
CU17100	Bolt-together adjustable shank	12"	2"	6"
CU17102	Bolt-together adjustable shank	14"	2"	6"
CU17103	Bolt-together adjustable shank	16"	2"	6"
CU17120	Bolt-together adjustable shank	12"	5.625"	8.875"
CU17121	Bolt-together adjustable shank	14"	6"	10.25"
CU17122	Bolt-together adjustable shank	16"	6"	10.25"
CU17123	Bolt-together adjustable shank	9"	7"	10.5"
CU17124	Bolt-together adjustable shank	11"	8.75"	0
CU17125	Bolt-together adjustable shank	10"	14.5"	0



Make sure to have the correct **LENGTH**, **RISE** and **DROP** required when selecting the proper shank for your weight distribution hitch. Use the diagram to the right to help you.

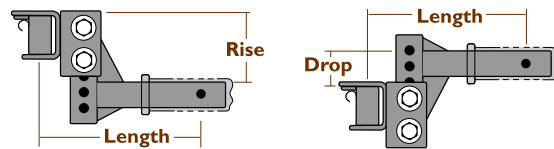

2 SPRING BARS				
CU17104	600 lb Round Spring Bar Style Kit (2) Spring bar chains and fasteners	N/A	N/A	N/A
CU17105	800 lb Round Spring Bar Style Kit (2) Spring bar chains and fasteners	N/A	N/A	N/A
CU17106	1000 lb Round Spring Bar Style Kit (2) Spring bar chains and fasteners	N/A	N/A	N/A
CU17304	600 lb Trunnion Spring Bar Style Kit (2) Spring bar chains and fasteners	N/A	N/A	N/A
CU17305	800 lb Trunnion Spring Bar Style Kit (2) Spring bar chains and fasteners	N/A	N/A	N/A
CU17306	1000 lb Trunnion Spring Bar Style Kit (2) Spring bar chains and fasteners	N/A	N/A	N/A

17104 / 17105 / 17106



17304 / 17305 / 17306



3 REPLACEMENT WD HEADS				
CU17107	For Round bar	N/A	N/A	N/A
CU17307	For Trunnion style	N/A	N/A	N/A



4 HOOK-UP BRACKET				
CU17108	Hook-up brackets (2)	N/A	N/A	N/A
CU17208	Hook-up brackets (2) for trailer with LP tanks	N/A	N/A	N/A



RV Hitch Class 3 Receiver 5,000 WC 6,000 WD

Part #	Description	Rating
CU13701	Adjustable RV hitch w/ 2" drop (receiver tube under the main body) to fit frames up to 51" wide	Class 3
CU13702	Adjustable RV hitch to fit frames up to 51" wide	Class 3



C



Tuff Tow X-Duty Weight Distributing Bars



TTR1400 - Up to 14K

1,400 Pound Round Bar WD Hitch complete with standard TT4010 2"X2" Adjustable Hitch Bar. Larger Diameter Spring Bars

Reinforced Hitch Head

Round Bar 600, 800 & 1000 Spring Bars do not interchange with the 1400 X-Duty Round Bar Weight Distributing Hitch Head.

Optional 2" Deep Drop / Rise Adjustable Hitch Bars available (TT4013, TT4014 & TT4015)

Optional 2-1/2" Deep Drop / Rise Adjustable Hitch Bars available (TT5013, TT5014 & TT5015)

Round Bar Weight Distribution

TTR600 - Complete Kit / 600 lbs

TTR800 - Complete Kit / 800 lbs

TTR1000 - Complete Kit / 1000 lbs

Includes Standard TT4010 2" x 2" Drop Shank!

TTQF1000-Quick fit kit with extended shank

Round Bar Weight Distribution Parts

TTWDCK - Replacement Chain Kit

TTWDHB - Replacement Hook Up Bracket

TTWHEAD - Replacement Head

TTWDBK - Bolt Kit

TTWDHH - Handle Kit

TTWDSC - Replacement Spring Bar Locking Device



TTWDClip - Replacement Clip

TTWD14HEAD-1400 TUFF TOW WEIGHT DIST HEAD ONLY REPLACEMENT 14K ONLY

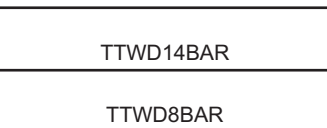

TTQF1000

 TTWDCK	 TTWDClip	 TTWD14HEAD	
 TTWDHH	 TTWDSC	 TTWDHB	

 TTWD10BAR	1,000 lbs BAR KIT TUFF TOW 1 PAIR WCHAIN KIT
 TTWD14BAR	1,400 lbs BAR KIT TUFF TOW 1 PAIR WCHAIN KIT
 TTWD8BAR	800 lbs BAR KIT TUFF TOW 1 PAIR WCHAIN KIT
 TTWD14HEAD	1400 TUFF TOW WEIGHT DIST HEAD ONLY REPLACEMENT 14K ONLY

Selecting the Right Ball Mount

INCORRECT



Trailer Not Level

For safe, comfortable towing, the trailer should always be set up to tow on a level plane.

CORRECT



Trailer Level

Sometimes a trailer's tongue is higher or lower than the ball mount on the vehicle, and a ball mount with a "rise" or a "drop" is required to level the trailer.

Ball Mount Measurements

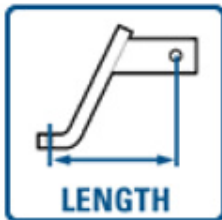

Distance from the center of the ball hole to the center of the pin hole

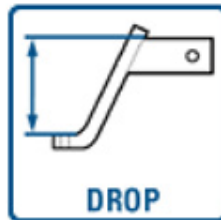

Distance from the top of the shank to the top of the ball platform

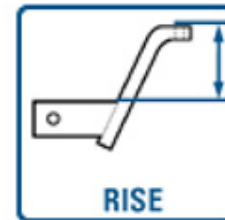

Distance from the top of the shank to the top of the ball platform

C

Measuring For the Proper Ball Mount



1. Measure from the ground to the top of the hitch.

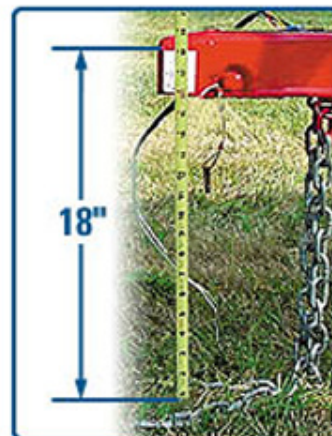

2. Measure from the ground to the (inside) top of the trailer coupler, when level.

3. Subtract the height of the hitch ball (most are 2½" - 3" high) from coupler measurement.

4. An 8" drop is needed to make the trailer level.

THE DIFFERENCE IN THE TWO MEASUREMENTS IS THE AMOUNT OF BALL MOUNT "RISE" OR "DROP" REQUIRED.

Information provided by Cequent Towing Products

CURT Trailer Balls Feature:

- Durable, attractive nickel chrome or stainless steel finish
- Fine threads for more holding strength
- Meets U.S. V-5 specifications
- Tested for safety

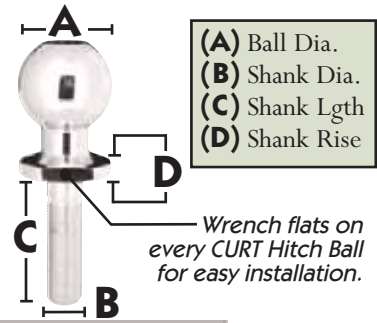

TRAILER BALL DIMENSIONS TRAILER BALL FINISHES & PART #S

BALL DIA (A)	SHANK DIA (B)	SHANK LENGTH (C)	SHANK RISE (D)	BALL CAP.	CHROME BULK	CHROME PACKGD	STAINLESS BULK	STAINLESS PACKGD	RAW
1 7/8"	3/4"	1 5/8"	0	2,000 lbs	CUA-1	CUA-61			
	3/4"	2 1/8"	0	2,000 lbs	CUA-15	CUA-63	CUA-50	CUA-80	
	3/4"	3"	0	2,000 lbs	CUA-16	CUA-71			
	1"	2 1/8"	0	3,500 lbs	CUA-2	CUA-62	CUA-51	CUA-81	
	1"	3"	0	3,500 lbs	CUA-17	CUA-72			
	1"	2 1/8"	1"	3,500 lbs	CUA-31				
	1"	2 1/8"	2"	3,500 lbs	CUA-32				
2"	3/4"	1 3/4"	0	3,500 lbs	CUA-3	CUA-64			
	3/4"	2 1/8"	0	3,500 lbs	CUA-18	CUA-65	CUA-52	CUA-82	
	3/4"	3"	0	3,500 lbs	CUA-19	CUA-73			
	1"	2 1/8"	0	6,000 lbs	CUA-4	CUA-66	CUA-53	CUA-83	
	1"	2 1/4"	0	12,000 lbs	CUA-38 HC				
	1"	2 1/8"	1"	6,000 lbs	CUA-33				
	1"	2 1/8"	2"	6,000 lbs	CUA-34				
	1"	3"	0	6,000 lbs	CUA-20	CUA-74			
	1"	2 1/8"	0	7,500 lbs	CUA-37				
	1 1/4"	2 1/4"	0	10,000 lbs	CUA-90 HC				
2 5/16"	1"	2 1/8"	0	7,500 lbs	CUA-5	CUA-67	CUA-54	CUA-84	
	1"	2 1/4"	0	10,000 lbs	CUA-7				
	1"	2 1/4"	0	12,000 lbs	CUA-39 HC				CUA-42
	1"	3"	0	6,000 lbs	CUA-21	CUA-75			
	1 1/4"	2 1/4"	0	10,000 lbs	CUA-6	CUA-68			
	1 1/4"	2 1/4"	1"	10,000 lbs	CUA-35				
	1 1/4"	2 1/4"	2"	10,000 lbs	CUA-36				
	1 1/4"	2 1/4"	1"	25,000 lbs					CUA-43
	1 1/4"	2 1/4"	2"	25,000 lbs					CUA-44
	1 1/4"	2 1/4"	0	30,000 lbs					CUA-41 HC
	1 1/4"	3"	0	6,000 lbs	CUA-22	CUA-76			
	2"	3 1/2"	0	30,000 lbs					CUA-91 HC
	3"	2"	3 1/4"	0	30,000 lbs				

Trailer Ball Packaging



Heat Treated,
Coarse Thread



Replacement Nuts & Washers

Pkg #	Description
CUA-103	3/4" replacement nut & lock washer
CUA-104	1" replacement nut & lock washer
CUA-105	1 1/4" replacement nut & lock washer

Torque Specifications

Shank Dia.	Torque Spec
3/4"	160 ft. lbs.
1"	250 ft. lbs.
1 1/4"	450 ft. lbs.

Switch Ball™

DESIGNED FOR SAFETY AND TOP PERFORMANCE



Slide on. Twist. Ready to Tow!

- No tools required.
- No attachment pin to remove.
- More time for recreation, less time in preparation.

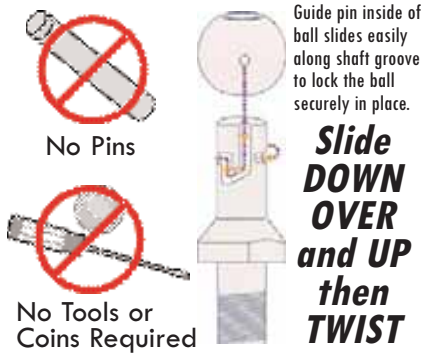

- Constructed from premium grade steel with nickel-chrome plating for long life.
- Switch~Ball™ is guaranteed for life against defects in manufacturing.
- Switch~Ball™ complies with National Standard SAE-J684 and V-5 Regulations for conversion ball sets.
- The exclusive 'J' Groove design ensures with the ball installed on the shank and engaged by a coupler, the hitching system is secure and has been proven safe through independent testing.
- Designed so the weight bearing capacity is resting on the shank taking the stress away from the ball freeing the coupler from friction and binding, providing smoother and safer towing.
- US Patent #5,169,168 Canadian Patent #1,325,445.

REPLACEMENT PARTS AVAILABLE

SWITCH ~ BALL™

Bulk #	PKG #	Finish	Description	Capacity
--	CU107820	chrome	set: 1" shank with 1 7/8" & 2" balls	6,000
--	CU182025	chrome	set: 1" shank with 1 7/8", 2" & 2 5/16" balls	8,000
--	CU182800	chrome	set: 1" shank with 2" & 2 5/16" balls	8,000
--	CU347820	chrome	set: 3/4" shank with 1 7/8" & 2" balls	3,500
--	CU347821	chrome	set: 3/4" long shank - with 1 7/8" & 2" balls	3,500
--	CU350001P	N/A	Storage case	n/a
--	CU350002P	N/A	Black Shank Cover, 3/4" shank	n/a
--	CU350003P	N/A	Red Shank Cover, 3/4" shank	n/a
--	CU350004P	N/A	Black Shank Cover, 1" shank	n/a
--	CU350005P	N/A	Red Shank Cover, 1" shank	n/a



SWITCH ~ BALL™ Replacement Balls

Bulk #	PKG #	Size	Description	Capacity
CU780003	CU780003P	1 7/8"	replacement Ball	6,000 lb
CU780000	CU780000P	1 7/8"	replacement Ball	8,000 lb
CU200000	CU20000P	2"	replacement Ball	6,000 lb
CU200003	CU20003P	2"	replacement Ball	8,000 lb
CU230003	CU23003P	1 5/8"	replacement Ball	8,000 lb

SWITCH ~ BALL™ Replacement Shanks

Bulk #	PKG #	Size	Description	Capacity
CU 340000	--	3/4"	replacement Shank	3,500 lb
CU340001	--	3/4"	replacement long Shank	3,500 lb
CU100000	--	1"	replacement Shank	6,000 lb
CU180003	--	1"	replacement Shank	8,000 lb



C

All CURT Ball Mounts Feature:

-  **CNC forming**
-  **Robotic welding**
-  **Mechanical descaling**
-  **Durable powder coat finish**



Style 1



Style 2



Style 3

• For detailed instructions on how to choose a ball mount, please turn to page 5 of this catalog

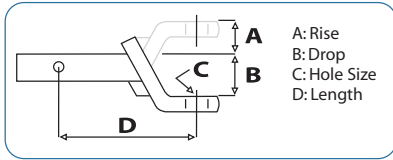

*See PG 6 for more information

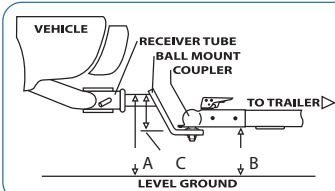

HOW TO CALCULATE BALL MOUNT DROP to determine what size drop or rise needed for your ball mount, level your trailer and calculate the following:

- A: The distance from the ground to the top ID of the receiver tube opening.
 - B: The distance from the ground to the bottom of the trailer coupler.
 - C: The difference from both measurements will determine the size of drop or rise you need.
- $A - B = C$



CUD-18

Class 1 / Class 2 Ball Mounts

- Fits 1 1/4" x 1 1/4" receiver tubes
- Solid tube

Bulk #	Pkg #	Finish	GTW /TW	Hole Size	Drop	Rise	Length	Style
CUD-18	--	Black	3,500/300	3/4"	1 1/4"	3/4"	6 3/4"	1
CUD-19	--	Black	3,500/300	3/4"	1 1/4"	3/4"	9 3/4"	1
CUD-20	--	Black	3,500/300	3/4"	N/A	3 7/8"	9 3/4"	N/A
CUD-21	--	Black	3,500/300	3/4"	3 1/4"	2 5/8"	7 1/4"	3
CUD-221	--	Black	3,500/300	3/4"	N/A	3 7/8"	11 1/4"	3



D-1

Black Powder Coat Ball Mounts

- Fits 2" x 2" receiver tubes

Bulk #	Pkg #	Finish	Class	GTW /TW	Hole Size	Drop	Rise	Length	Gusset	Style
CUD-1	D-1P	Black	3	6,000/600	1"	2"	3/4"	8 1/4"	No	1
--	*D-1PC	Black	3	6,000/600	1"	2"	3/4"	8 1/4"	No	1
CUD-2	--	Black	3	6,000/600	1"	2"	3/4"	10 1/4"	No	1
CUD-25	--	Black	3	6,000/600	1"	2"	3/4"	12 1/4"	No	1

* PC Ball mounts come in a plain white box with 5/8" hitch pin and clip.



CUD-45

Chrome-Plated Ball Mounts

- Manufactured using all the same processes as our other popular models, but taking it one step further with a polishing process to assure a mirror finish
- Fits 2" x 2" receiver tubes

Bulk #	Pkg #	Finish	Class	GTW /TW	Hole Size	Drop	Rise	Length	Gusset	Style
CUD-45	--	chrome	3	6,000/600	1"	2"	3/4"	8 1/4"	No	2
CUD-46	--	chrome	3	6,000/600	1"	4"	2"	8 1/4"	No	2
CUD-47	--	chrome	3	6,000/600	1"	6"	4"	8 1/4"	Yes	2

Black Powder Coat Ball Mounts

• Fits 2" x 2" receiver tubes



Bulk #	Pkg #	Finish	Class	GTW /TW	Hole Size	Drop	Rise	Length	Gusset	Style
CUD-3	CU D-3P	Black	3	6,000/600	1"	2"	3/4"	8 1/4"	No	2
--	CU *D-3PC	Black	3	6,000/600	1"	2"	3/4"	8 1/4"	No	2
CUD-4	--	Black	3	6,000/600	1"	2"	3/4"	10 1/4"	No	2
CUD-26	--	Black	3	6,000/600	1"	2"	3/4"	12 1/4"	No	2
CUD-5	CU D-5P	Black	3	6,000/600	1"	4"	2"	8 1/4"	No	2
--	CU *D-5PC	Black	3	6,000/600	1"	4"	2"	8 1/4"	No	2
CU D-6	--	Black	3	6,000/600	1"	4"	2"	10 1/4"	No	2
CU D-27	--	Black	3	6,000/600	1"	4"	2"	12 1/4"	No	2
CUD-7	--	Black	3	6,000/600	1"	6"	4"	8 1/4"	Yes	2
CUD-8	--	Black	3	6,000/600	1"	6"	4"	10 1/4"	Yes	2
CUD-28	--	Black	3	6,000/600	1"	6"	4"	12 1/4"	Yes	2
CU D-9	--	Black	3	5,000/500	1"	8"	6"	8 1/4"	Yes	2
CU D-10	--	Black	3	5,000/500	1"	8"	6"	10 1/4"	Yes	2
CU D-11	--	Black	3	5,000/500	1"	10"	8"	8 1/4"	Yes	2
CU D-12	--	Black	3	5,000/500	1"	10"	8"	10 1/4"	Yes	2

* PC Ball mounts come in a plain white box with 5/8" hitch pin and clip.

CURT Custom COLORS
 Just add the color code to one of the following Ball Mount part #'s:



EXAMPLE: D-3 -01 (2" drop) - *Bright Red*

- 10 Custom Colors are available in this style of ball mount
- Turn to page 8 and 9 for Custom Color details

Bulk #	Pkg #	Drop	Length	Color Code -Finish				
*D-3-##	--	2"	8 1/4"	01 -Bright Red	02 -Dark Red	03 -White	04 -Intense Blue	05 -Dark Blue
				06 -Dark Green	07 -Charcoal	08 -Light Pewter	09 -Tan/Gold	10 -Yellow
*D-5-##	--	4"	8 1/4"	01 -Bright Red	02 -Dark Red	03 -White	04 -Intense Blue	05 -Dark Blue
				06 -Dark Green	07 -Charcoal	08 -Light Pewter	09 -Tan/Gold	10 -Yellow

* Refer to Black Powder Coat Ball Mounts above for complete D-3 and D-5 Ball Mount specifications.

ALL CUSTOM COLORS SPECIAL ORDER

Also Available in: **CURT Custom COLORS**

- Custom Color Receiver Hitches
- Custom Color Tube Covers
- Custom Color Trailer Ball Covers

C

C



Ready Tow Ball Mounts

- Ball Mounts come complete with "FACTORY TORQUED" Curt Trailer Ball and F-5 Receiver Pin.

Bulk #	Finish	Class	GTW /TW	Ball Mount	Trailer Ball	Pin & Clip
CUD-532	Black	3	3,500/350	CUD-3 (2" drop, 3/4" rise, 8 1/4" length)	CUA-2 (1 7/8" x 1" x 2 1/8")	F-5 (5/8")
CUD-534	Black	3	6000/600	CUD-3 (2" drop, 3/4" rise, 8 1/4" length)	CUA-4 (2" x 1" x 2 1/8")	F-5 (5/8")
CUD-552	Black	3	3,500/350	CUD-5 (4" drop, 2" rise, 8 1/4" length)	CUA-2 (1 7/8" x 1" x 2 1/8")	F-5 (5/8")
CUD-554	Black	3	6000/600	CUD-5 (4" drop, 2" rise, 8 1/4" length)	CUA-4 (2" x 1" x 2 1/8")	F-5 (5/8")
CUD-4534	Chrome	3	3,500/350	CUD-45 (2" drop, 3/4" rise, 8 1/4" length)	CUA-2 (1 7/8" x 1" x 2 1/8")	F-5 (5/8")
CUD-4554	Chrome	3	6000/600	CUD-45 (2" drop, 3/4" rise, 8 1/4" length)	CUA-4 (2" x 1" x 2 1/8")	F-5 (5/8")



Ready Tow Kit 3 Pack

- Three Loaded Ball Mounts packed in an attractive shelf display
- Ball Mounts come complete with "FACTORY TORQUED" Curt Trailer Ball and F-5 Receiver Pin

Bulk #	Finish	Class	GTW /TW	Ball Mount	Trailer Ball	Pin & Clip
CUD-532MP	Black	3	6000/600	CUD-3 (2" drop, 3/4" rise, 8 1/4" length)	CUA-2 (1 7/8" x 1" x 2 1/8")	F-5 (5/8")
CUD-534MP	Black	3	6000/600	CUD-3 (2" drop, 3/4" rise, 8 1/4" length)	CUA-4 (2" x 1" x 2 1/8")	F-5 (5/8")
CUD-554MP	Black	3	6000/600	CUD-5 (4" drop, 2" rise, 8 1/4" length)	CUA-4 (2" x 1" x 2 1/8")	F-5 (5/8")



RIGHTANGLE Ball Mounts

- Fits 2" x 2" receiver tubes
- RIGHTANGLE ball mount features an ergonomic design that makes it easy to plug into the receiver and go

Bulk #	Pkg #	Finish	Class	GTW /TW	Hole Size	Drop	Rise	Length	Gusset	Style
CU D-4RA	--	Black	3	6,000/600	1"	2"	3/4"	10 1/4"	No	2
CU D-6RA	--	Black	3	6,000/600	1"	4"	2"	10 1/4"	No	2
CU D-8RA	--	Black	3	6,000/600	1"	6"	4"	10 1/4"	No	2

CURT Universal Ball Mounts

- Universal length adjusts from 8 1/4" to 10 1/4"
- Fits 2" x 2" receiver tubes



Bulk #	Pkg #	Finish	Class	GTW/TW	Hole Size	Drop	Rise	Length	Gusset	Style
CUD-22	--	Black	3	6,000/600	1"	2"	3/4"	8 1/4" & 10 1/4"	No	2
CUD-23	--	Black	3	6,000/600	1"	4"	2"	8 1/4" & 10 1/4"	No	2
CU D-24	--	Black	3	6,000/600	1"	6"	4"	8 1/4" & 10 1/4"	Yes	2

MAGNUM V One Piece Forged Ball Mounts

- These units are used when heavy duty towing is required
- Fits 2" x 2" receiver tubes



Bulk #	Pkg #	Finish	Class	GTW/TW	Hole Size	Drop	Rise	Length	Gusset	Style
CUD-122	--	Black	5	12,000/1,200	1 1/4"	2"	3/4"	8 1/4"	No	2
CU D-124	--	Black	5	12,000/1,200	1 1/4"	4"	2"	8 1/4"	No	2
CU D-126	--	Black	5	12,000/1,200	1 1/4"	6"	4"	8 1/4"	No	2

Multi Ball Mounts

- Double or Triple Ball Mounts offer 1 7/8", 2" and 2 5/16" ball sizes with either chrome or black finish balls
- Fits 2" x 2" receiver tubes
- Solid tube



Bulk #	Pkg #	Finish	Ball Finish	Class	GTW/TW	Drop	Rise	Length	Welded Balls
CUD-150	--	Black	Black	3-4	10,000	--	--	8 1/2"	1 7/8", 2" & 2 5/16"
CUD-155	--	Black	Chrome	3-4	10,000	--	--	8 1/2"	1 7/8", 2" & 2 5/16"
CUD-160	--	Black	Black	3-4	10,000	--	--	8 1/2"	2" & 2 5/16"
CUD-165	--	Black	Chrome	3-4	10,000	--	--	8 1/2"	2" & 2 5/16"

Receiver Adapters

- One piece unit used for converting the size of the receiving tube to either 1 1/4" or 2"

Bulk #	GTW/TW	Description	Adapts from	Adapts to	Extends
CUD-170	3,500/350	Receiver Adapter	2"	1 1/4"	4"
CU D-175	3,500/350	Receiver Adapter	2"	1 1/4"	9.5"
CU D-180	3,500/350	Receiver Adapter	2"	1 1/4"	15"
CUD-185*	350 TW	Receiver Adapter	1 1/4"	2"	6 1/4"
CU D-190*	350 TW	Receiver Adapter	1 1/4"	2"	10"
CU D-191	3,500/350	Receiver Extender	2"	2"	8"
CUD-195	3,500/350	Receiver Extender	2"	2"	14"
CU D-205	3,500/350	Receiver Extender	2"	2"	18"



* NOT FOR TOWING USE

C

CUD-312



Adjustable Ball Mount

- Easily adjusts from 2" to 7½" drop and up to 6" rise
- Eliminates the need for multiple ball mounts
- Fits 2" x 2" receiver tubes

Bulk #	Pkg #	Finish	Class	GTW/TW	Hole Size	Drop	Rise	Length
CUD-312	--	Black	3	5,000/500	1"	7 ½" max	6 ¼" max	12 ½"

CUD-43



Reversible Ball Mounts

- Fits 2" x 2" receiver tubes

Bulk #	Pkg #	Finish	Ball Finish	Class	GTW/TW	Drop	Rise	Length	Welded Balls
CUD-43	--	Black	black	3	6,000/600	--	--	8 ½"	1 7/8" & 2"
CUD-44	--	Black	black	3	6,000/600	--	--	8 ½"	2" & 2 5/16"



SUPER DUTY

CURT Super Duty Ball Mounts

- Fits 2 ½" x 2 ½" receiver tubes

Bulk #	Pkg #	Finish	Class	GTW/TW	Hole Size	Drop	Rise	Length	Style
CUD-2525	n/a	Black	IV-V	10,000/1,000	1 1/4"	3"	1 1/2"	9 3/4"	2
CUD-2526	n/a	Black	IV-V	10,000/1,000	1 1/4"	5"	3 1/2"	10"	2
CUD-2527	n/a	Black	IV-V	10,000/1,000	1 1/4"	8"	6 1/4"	10 1/2"	2



Adapter Sleeve

- Durable Adapter Sleeve converts oversized 2½" receiver tubes to fit a standard 2" ballmount .

Bulk #	Pkg #	Finish	Description
CUD-2505	--	Black	Converts oversized 2½" receiver tubes to fit a standard 2" ballmount

Clevis Pin Ball Mount

- Fits standard 2" receivers
- Can be used as a standard ball mount
- Used primarily with industrial/agricultural couplings
- Hitch Pin and clip included
- Fits 2" x 2" receiver tubes
- Solid tube



Bulk #	Pkg #	Finish	Class	GTW/TW	Hole Size	Length
CU D-321	--	Black	N/A	6,000/600	1"	8 3/4"

Tow Strap Mount

- Best for use with tow straps with hooks
- Fits standard 2" receivers
- Complete with shackle and solid shank
- Fits 2" x 2" receiver tubes
- Solid tube



Bulk #	Pkg #	Finish	Class	GTW/TW	Hole Size	Length
CU D-324	--	Black	N/A	Limited to Hitch Capacity	N/A	7 1/2"

Tow Hook Mount

- Fits standard 2" receivers
- Use with J-66 vehicle recovery strap or similar
- Fits 2" x 2" receiver tubes



Bulk #	Pkg #	Finish	Class	GTW/TW	Hole Size	Length
CU D-325	--	Black	N/A	Limited to Hitch Capacity	N/A	7 1/2"

Towing Accessory Kit

- Convenient towing accessory kit
- Ball Mount (D-4 or D-6), Tube Cover (F-17), Pin & Clip (F-5) and Trailer Ball (A-4) included
- Packed in convenient, reusable case

Part #	Finish	Class	GTW	Description
CU D-4K	Black/Chrome/zinc	3	6000/600	2" drop towing accessory kit
CU D-6K	Black/Chrome/zinc	3	6000/600	4" drop towing accessory kit



D-4K



D-6K

Anti Rattle Kit

- Used with hollow-shank bike racks, ball mounts or other accessories to stop rattles and prevent swaying of the load.

Part#	Description
CUF-315	1 1/4"
CUF-321	2" For Bike Racks



C

DEEP DROP BALL MOUNTS

C

BALL MOUNTS

 AA1116-3	12"DROP 10"L 10KMGTW SOLID BALL MT BLACK
 AA1116-4	14"DROP 10" L 7,500 MGTW SOLID BALL MT
 AA1116-5	CHROME 14"DROP 10" L 5,000 MGTW SOLID BALL MT
 AA1116-6	16"DROP 10" L 7,500 MGTW SOLID BALL MT
 AA1116-7	CHROME 16"DROP 10" L 5,000 MGTW SOLID BALL MT
 AA1116-8	18"DROP 10" L 7,500 MGTW SOLID BALL MT
 AA1116-9	CHROME 18"DROP 10" L 5,000 MGTW SOLID BALL MT
 AA1124	CAMPER 2 STEPS FITS 2" RECEIVERS BLK 20 LBS . NON SKID TAPE

Black Ball Mounts 5,000 - 6,000 lbs. Class III - 2x2

Description	Tuff Tow	FT	Buyers	FT	DRAW-TITE	FT	Hidden Hitch	FT	FT
2" Drop, 8" Long			1803005	B,6					A,5
2" Drop, 8-1/2" Long					40342	A,6	HH80227	C,6	
2" Drop, 8-3/4" Long					2713	B,5			
2" Drop, 9" Long	TT2729	C,6							
2" Drop, 10" Long	TT2739	C,6							
2" Drop, 10-1/2" Long					40343	C,6			
2" Drop, 12" Long					2736	B,5			
3-1/4" Drop, 8" Long									A,5
3-1/4" Drop, 8-1/2" Long	TT2746	C,6							
3-1/4" Drop, 8-3/4" Long	TT2766	C,6							
3-3/8" Drop, 10" Long									
4" Drop, 8" Long			1803010	A,6					A,5
4" Drop, 9" Long					40344	C,6			
4" Drop, 11" Long					40345	C,6	HH80228	C,5	
5-1/4" Drop, 8-3/4" Long	TT2773	A,6							A,5
6" Drop, 9-1/2" Long					40346	C,6			
6-1/2" Drop, 9" Long	TT2786	A,6							
8" Drop, 9" Long	TT2793	A,6							A,5
8" Drop, 10" Long					2793	B,5			
11" Drop, 9" Long					2706	B,5			
11" Drop, 11-1/2" Long	TT2796	A,3							
2.25" Drop 12" long 6K									

Foot Notes: A = 90 Deg. B = Straight C = Angle 3 = Drop 6,000 lbs - Rise 3,500 lbs.
5 = 5,000 lbs. 6 = 6,000 lbs.

Chrome Ball Mounts 5,000 - 6,000 lbs Class III - 2x2

Description	Tuff Tow	FT	Buyers	FT	DRAW-TITE	FT	Hidden Hitch	FT	FT
2" Drop, 8.5" Long							HH80207	C,6	
3-1/2" Drop, 8-1/2" Long									
4" Drop, 10" Long							HH80209	A,5	
6" Drop, 10" Long							HH80205	A,5	
8" Drop, 10" Long							HH80203	A,5	

Foot Notes: A = 90 Deg. B = Straight C = Angle 5 = 5,000 lbs. 6 = 6,000 lbs.

Stainless Steel Ball Mounts 5,000 - 6,000 lbs Class III - 2x2

Description	Tuff Tow	FT	Buyers	FT	DRAW-TITE	FT	FT	FT
2" Drop, 8" Long			1803070					
2" Drop, 9" Long					40172			
3-1/4" Drop, 9-1/2" Long			1803073		40176			
3" Drop 8.25" Long								

Solid Forged Ball Mounts 10,000 to 12,000 lbs class IV 2x2 1-1/4" hole

Description	Tuff Tow	FT	Buyers	FT	DRAW-TITE	FT	FT	FT
2" Drop, 8-1/2" Long			#1803051	C	40330	C	1803051	
4" Drop, 9-1/4" Long			#1803056	C	40331	C	1803056	
6" Drop, 10-1/4" Long					40332	C	re-rated to 20,000lbs	

Foot Notes: A = 90 Deg. B = Straight C = Angle

Power pull style ball mount is constructed of a welded tube in a tube not solid

Solid Zinc Ball Mounts 10,000 lbs Class IV - 2x2 - 1 1/4" Hole

Description	Tuff Tow	FT	Buyers	FT	DRAW-TITE	FT	FT	FT
2" Drop, 8-1/2" Long					4280	B		
2" Drop, 12" Long					4284	B		
4" Drop, 8-1/2" Long					4281	A		
4" Drop, 12" Long					4285	A		
6" Drop, 9-1/2" Long					4282	A		
8" Drop, 9-1/2" Long					4283	A		

Foot Notes: A = 90 Deg. B = Straight C = Angle

Hollow Shank 10K Black

Description	Tuff Tow	FT	BUYERS	DRAW-TITE	FT	FT	FT
2" Drop 8-1/2" long				40200			
4" Drop 9" Long				40201			
4" Drop 11-1/4" Long				40202			
6" drop 9" long				40205			
8" drop 9" Long				40206			

Ball Mounts 12,000 lbs Class V - 2 1/2 x 2 1/2 - 1 1/4" Hole

Description	Tuff Tow	FT	Buyers	FT	DRAW-TITE	FT	Hidden Hitch	FT
3" Drop, 9-1/2" Long					45122	C		
5" Drop, 10" Long					45123	C		
7-3/4", 10-1/2" Long					45124			

Class V 2-1/2" Square Shank

Foot Notes: A = 90 Deg. B = Straight C = Angle

C BALL MOUNTS

* = Special Order/Non-stock

40565 Class III Starter Kit 2" Drop 8-1/2" Long 2" Sq.

Big Drop 2x2			
Description	Finish	Part No.	Rating
14" Drop 10" Length Solid Shank	Chrome	AA1116-5	5K
16" Drop 10" Length Solid Shank	Chrome	AA1116-7	5K
18" Drop 10" Length Solid Shank	Chrome	AA1116-9	5K

Big Drops 2X2

Description	Action Accessories	
12" DROP 10" L 10,000 MGTW SOLID BALL MT	AA-1116-3	Black
14" DROP 10" L 7,500 MGTW SOLID BALL MT	AA1116-4	Black
16" DROP 10" L 7,500 MGTW SOLID BALL MT	AA1116-6	Black
18" DROP 10" L 7,500 MGTW SOLID BALL MT	AA1116-8	Black
14" DROP 10" L 5,000 MGTW SOLID BALL MT	AA1116-5	Chrome
16" DROP 10" L 5,000 MGTW SOLID BALL MT	AA1116-7	Chrome
18" DROP 10" L 5,000 MGTW SOLID BALL MT	AA1116-9	Chrome

Ball Mount Kits - Includes Pin & Clip & Ball

Description	Tuff Tow	FT	Buyers	FT	DRAW-TITE	FT	Hidden Hitch	FT	Valley	FT
2" Drop, Black - 1 7/8" Ball					40564-002*					C,5
2" Drop, Chrome - 2" Ball			B1803306	A,5						
2" Drop Black - 2" Ball			B1803307	A,5	40563-002*					C,5
4" Drop Black - 2" Ball			B1803313	A,5	40566-002*					

Foot Notes: A = 90 Deg. B = Straight C = Angle 3 = 3,500 lbs. 5 = 5,000 lbs. 6 = 6,000 lbs.
 *=Sold in 2 pack

2" DROP CHROME MOUNT 2" BALL 5K W/LOCK PIN	B1803306LP	5K
4" Drop 2-5/16" Ball Black Sold Each	B1803314	6K
2" Drop 2-5/16" Ball Black Mt	B1803308	6K

Black Ball Mount Kits - Includes Pin & Clip - 2 x 2 - Class III

Description	Tuff Tow	FT	Buyers	FT	DRAW-TITE	FT	
2" Drop, 8-1/2" Long					2923	A,5	
2" Drop, 8-1/2" Long					40442	C,6	WSL
2" Drop, 10-1/2" Long					40443	C,6	
4" Drop, 8" Long					2953	A,5	
4" Drop, 9" Long						C,6	
4" Drop, 11" Long					40445	C,6	
6" Drop, 9-1/2" Long					40446	C,6	
8" Drop, 10" Long						A,5	

Foot Notes: A = 90 Deg. B = Straight C = Angle 5 = 5,000 lbs. 6 = 6,000 lbs.

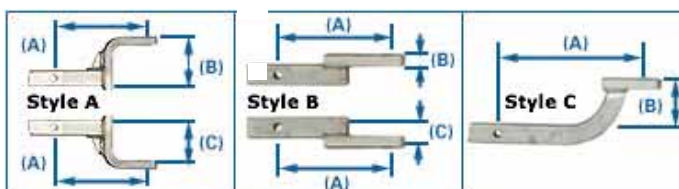

Ball Mount Kits - Includes Pin & Clip 1 1/4" Class II

Description	Style	TW	GTW	Part Number
1-1/4" Drop, 7" Long	2	350 lbs.	3500 lbs.	36051
1-1/4" Drop, 9-3/4" Long	2	350 lbs.	3500 lbs.	36053
3-1/8" Rise, 9-3/4" Long	3	350 lbs.	3500 lbs.	36061
3-1/8" Rise, 11-3/4" Long	3	350 lbs.	3500 lbs.	36063
5" Rise, 10" Long	3	350 lbs.	3500 lbs.	36065
3-1/4" Drop, 7-3/16" Long	1	350 lbs.	3500 lbs.	36071
4-3/4" Drop 7-3/8" Long	1	350 Lbs.	3500 lbs.	36078*

Note: Frame hitch drawbar applications are specific. The correct replacement Part # is listed on each frame hitch
 TRAILER HITCHES & ACCESSORIES - 52



40565



AA1116-5 /-6 /-7



AA1116-4



B1803313



B1803314



40442



36051

*OEM EXPLORER

C

BALL MOUNTS

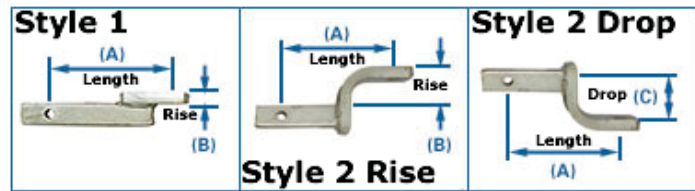

Draw-Tite Sportframe Drawbar Kits - Class I - 1 1/4" Shank 24 ser

Description	Style	TW	GTW	Part Number
6 5/8" Long, 5/8" Rise, 3/4" Pin Hole	1	200 lbs.	2000 lbs.	3590
9 3/4" Long, 5/8" Rise, 3/4" Pin Hole	1	200 lbs.	2000 lbs.	3591
9 3/4" Long, 2 1/8" Rise, 2 3/4" Drop, 3/4" Pin Hole	2	200 lbs.	2000 lbs.	3592
6 5/8" Long, 2 1/8" Rise, 2 3/4" Drop, 3/4" Pin Hole	2	200 lbs.	2000 lbs.	3593
10" Long, 4" Rise, 3/4" Pin Hole	2	200 lbs.	2000 lbs.	3594

Note: Frame hitch drawbar applications are specific. The correct replacement Part # is listed on each frame hitch



Description	Style	TW	GTW	Part No.
Drawbar Kit for OEM Dodge Magnum Hitch, Drawbar (# w/3/4" Ball Hole), Pin and Clip, Black			2000	83637

Anti Rattle Bracket

Description	Part #
Anti Rattle 1-1/4"	5700
Ball Wrench	62342

Clevis Ball Mounts

Description	Tuff Tow	FT	Buyers	FT	DRAW-TITE	FT	Hidden Hitch	FT
4-1/4" Long, 1" Pin Hole, Hollow			1803060	6				
4" Drop, 1" Pin Hole, Hollow							HH80410	6
9-3/4" Long, 3/4" Pin Hole, Hollow					5761	5		
8-7/8" Long, 1" Pin Hole, Hollow					5762	6		
8-7/8" Long, 1" Pin Hole, Solid					6201	8		
9 1/4" Long, 1" Pin Hole, Solid			1803065	8				
10 1/2" Long, 1" Pin Hole, Solid								

Foot Notes: Clevis Mount Rating 3 = 3,500 lbs. 5 = 5,000 lbs 6 = 6,000 lbs. 8 = 8,000 lbs. 9 = 9,000 lbs.

C BALL MOUNTS

* = Special Order/Non-stock

Adjustable Ball Mounts

Description	Tuff Tow	FT	Buyers	FT	DRAW-TITE	FT	Hidden Hitch	FT	FT
5-1/4" Drop, 12" Long					7390	*6			
7-1/2" Drop, 10" Long									5
7-3/6 Drop, 12" Long					6580	5			
7-1/4" Drop, 12" Long					1420	5			
7-1/4" Drop, 14" Long					1422	5			
7-1/4" Drop, 16" Long					1424	5			
11" Drop			1803090	3					

* Adjustable Ball Mount with Sway Control Tab

Foot Notes: 3 = 3,500 lbs. 5 = 5,000 lbs. 6 = 6,000 lbs.



Adjustable Height Zero Tilt Ball Mount

Description	WC Cap.	TW Cap.	Master Lock
Infinitely adjusts from 7-3/4" drop to 6-1/4" rise Adjustable Height Zero Tilt Ball Mount Powder Coated / Chrome Plated Steel; Adjustable Height Zero Tilt; 1" Shank Diameter; Class III; <i>Ball not Included</i>	5,000 lbs.	500 lbs.	2841AT

Draw-Tite Multiple-Ball Ball Mounts - Class III - 2" Shank

Description	TW	GTW	Part Number
10" Long, 2" Drop, 1 7/8" Ball & 3/4" Rise, 2" Ball	600 lbs.	6000 lbs.	*80404

10" Long, 2" Drop, 2" Ball & 3/4" Rise, 2 5/16" Ball	600 lbs.	6000 lbs.	80406
---	----------	-----------	-------

Description	TW	GTW	Part Number
DOUBLE 1 7/8"-2" BALL MOUNT	600 lbs	6000 lbs	1802210
DUAL BALL SHANK 2" & 2 5/16" BALLS	600 lbs	6000 lbs	B1802215

RECEIVER MOUNT TRI-BALL HITCH

Single Piece Shank Designed to Fit 2 X 2 Receiver Tubes

Description	Ball Size	GTW	Part Number
Black Powder Coated Finish, Welded Steel Towing Balls Individually Boxed	1 7/8"	6,000	B1802200
	2"	10,000	
	2 5/16"	10,000	
Double Ball Mount	2"	7,500	B1802215
	2 5/16"	10,000	
Chrome Tri Ball Mount	1 7/8"	2,000	
	2"	5,000	
	2 5/16"	10,000	
Tri-Ball Ball Mount, 2" Sq. Solid Shank	1-7/8"	2000	80408
	2"	5000	
	2-5/16"	10,000	
Tri-Ball mount with chrome balls	1-7/8"	2000	80415
	2"	6000	
	2-5/16" balls	10,000	



2841AT



80406



B1802215 2" & 2 5/16"

1802210 1 7/8" & 2"



B1802200



80415

C

BALL MOUNTS

ADJUSTABLE RECEIVER MOUNT TRI-BALL HITCH
Single Piece Shank Designed to Fit 2 X 2 Receiver Tubes



B1802225

Description	Ball Size	GTW	Part Number
Black Powder Coated Finish	1 7/8"	6,000	B1802225
Chrome Welded Steel Towing Balls	2"	10,000	
	2 5/16"	10,000	
Shank only with balls.			B3003820
Replacement Pin			B3001919

C

BALL MOUNTS



C ANDERSON RAPID HITCH

 AM3503	 AM3505
 AM3507	 AM3509
 AM3511	 RH3310
 RH3426	 RH3427
 RH3323	 RH3342
 RH3331	 RH3440
	 RH3334

Part Number	Description
AM3503	2" Drop, 1" Hole Part
AM3505	4" Drop, 1" Hole Part
AM3507	6" Drop Part
AM3509	8" Drop Part
AM3511	10" Drop Part
RH3310	5 3/4" Maximum Drop
RH3313	10" Maximum Drop
RH3300	SUV 3 3/4" Drop
RH3426	1-7/8" only Replacement Ball 7.5K
RH3424	2"-2 5/16" 2 & 2 5/16 Replacement Ball
RH3427	Hair pin replacement
RH3323	BALL HOUSING ADJ NO BALLS
RH3342	10" DROP RACK SHANK ALUM.2"
RH3331	Pin replacement 4-1/4 x 5/8
RH3440	INTERNAL PIN REPLACEMENT
RH3610	RAPID HITCH DISPLAY STAND Free with purchase
RH3334	Keyed Locks set for Receiver & Adjustable shank rapid hitch fits all class 3,4 & 5 hitches
RH3328	Rapid Hitch Adjustment Keyed Lock



ANDERSEN MFG ALUMISTINGER BALL MOUNT



See previous page for part numbers



- * Available in a 2", 4", 6", 8" and 10" drop/rise
- * 1" Ball Hole - 8,000 lb. GVWRm 800TW * Aircraft aluminum alloy which is 30% stronger than steel weight-for-weight! * Lightest and strongest ball mount on the market! * NO paint - NO rust - FOREVER! * Fits a standard 2" receiver! * Fully tested and verified by an independent lab for a V-5 certification * A continuous shine that will last a lifetime!



RH3310

All Rapid Hitch sizes have a 10,000 lb. GTWR and 1,500 lb. tongue weight - limited by ball capacity.

Standard double ball features 2" and 2 5/16" balls.
 3 Models available: the SUV 3 1/2" drop/rise, the 5 1/2" drop/rise, and the 10" drop.
 The standard Rapid Hitch has 11" over-all vertical adjustment, 5 1/2" rise or drop.
 Fully tested and certified by an independent lab.
 Fits a 2" standard receiver hitch.
 Many optional balls available including:
 1 7/8" x 2" combo
 1 7/8" single ball
 2" single ball
 2 5/16" single ball



ALUMINUM - Solid Class III Ball Mounts 1" Ball Hole			
Draw-Tite Part No.	Drop	Capacity	
40381	2"	8K	
40382	4"	8K	
40383	6"	8K	
40384	8"	8K	

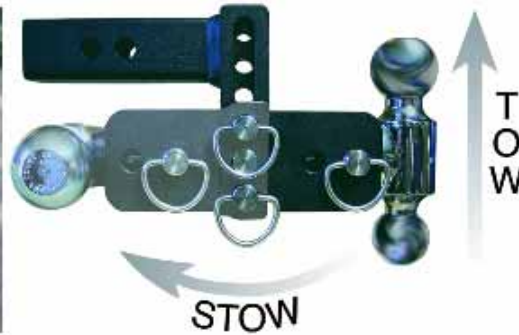

TOW & STOW MODEL CHART

Part Number	Ball Size	Description	Rating
6" Model 3" Drop			
TS10033B	2 5/16" x 2"	Double Ball	10K Class IV
* TS10035B	1 7/8" x 2"	Double Ball	10K Class IV
TS10047B	2" x 1 7/8" x 2 5/16"	Tri-Ball	10K Class IV
8" Model 5" Drop			
TS10037B	2 5/16" x 2"	Double Ball	10K Class IV
* TS10038B	1 7/8" x 2"	Double Ball	10K Class IV
TS10048B	2" x 1 7/8" x 2 5/16"	Tri-Ball	10K Class IV
10" Model 7" Drop			
TS10040B	2 5/16" x 2"	Double Ball	10K Class IV
* TS10049B	2" x 1 7/8" x 2 5/16"	Tri-Ball	10K Class IV
Browning 6" Model Browning Hitches			
* TS10033BB	2 5/16" x 2"	Double Ball	10K Class IV
* TS10047BB	2" x 1 7/8" x 2 5/16"	Tri-Ball	10K Class IV
8" Model			
* TS10037BB	2" x 2 5/16"	Double Ball	10K Class IV
* TS10048BB	2" x 1 7/8" x 2 5/16"	Tri-Ball	10K Class IV
Mossy Oak 6" Model Mossy Oak			
* TS10033MN	2 5/16" x 2"	Double Ball	10K Class IV
* TS10047MN	2" x 1 7/8" x 2 5/16"	Tri-Ball	10K Class IV
8" Model			
* TS10037MN	2 5/16" x 2"	Double Ball	10K Class IV
* TS10048MN	2" x 1 7/8" x 2 5/16"	Tri-Ball	10K Class IV
Pintle Hitch			
TS10055	Pintle Hitch 2" Ball		
* TS10056	Pintle Hitch 2 5/16" Ball		
* TS10051	2" Pintle Ball Chrome		
TS10052	2 5/16" Pintle Ball Chrome		
Tow & Stow Accessory Chart			
* TS51234	Tri-Max Stainless Steel Hitch Lock		
* TS50796	Loch-Pro Hitch Lock		
* TS35010	Stainless Steel Pins (Long)		
* TS35020	Silencer Pad (Black)		
* TS35012	6" Stainless Cover Plate		
* TS35013	8" Stainless Cover Plate		
* TS35014	10" Stainless Cover Plate		
* TS35016	6" Browning Cover Plate		
* TS35017	8" Browning Cover Plate		
* TS35012MN	6" Mossy Oak Cover Plate		
* TS35013MN	8" Mossy Oak Cover Plate		



Part Number	Description
49802	Fold down License plate Brkt.
SW2546	Superwinch 2" Receiver Shackle Bracket
RM1225E	Buyers 12K Receiver Towing Eye
5443	Hitch Mounted Lic Plate Holder
6771	Draw-Tite 2" Skid Plug Receiver Tube The Ultimate Tube Cover, Protects Hitch from Low Lying Obstacles
AA1124	Camper 2 Step for 2x2 receiver
6758	Draw-Tite 2" Service Step Receiver Tube Service Step Fea- tures Non-Skid Surface
1804010	Dual Receiver features a standard 12" extension plus a second 6" tube. Now you can tow your trailer and your Bike Rack (Bike Rack rides higher). Capacity: 4,000 lbs. MGTW - 400 lbs. max. verticle load. Weight: 19.5 lbs.
6715	Draw-Tite 2" Spare Tire Carrier Receiver Tube * Universal Spare Tire Carrier Universal Fit for All Makes of Rims, Great for RV's
T-05680	SAFETY STEP RUBBER TREAD 2PK 4" x 17.5" Keeper
B1804015	EXTENSION, RECEIVER ,W/STEP,12in,2in SQ. BUYERS
63046	Receiver Mount Tow Ring
1804055	RECEIVER TUBE, BOLT ON BUYERS



B1804015



1804055

SHACKLE BRACKET, TOW EYE, RECEIVER STEP

Combo Tubes (Receiver Tubes)



SB18 18

2 X 2 SOLID BAR SHANKS



Unpainted Part #	MFG Part #	Length	Diameter	Ring	Class
2850	RT25806	6"	2" x 2"	Forged	3
2851	RT25812	12"	2" x 2"	Forged	3
2898	RT58818	18"	2" x 2"	Forged	3
2852	RT25824	24"	2" x 2"	Forged	3
2853	RT25836	36"	2" x 2"	Forged	3
2854	RT25848	48"	2" x 2"	Forged	3
3006	3006	6"	1 1/4" x 1 1/4"	Standard	2
5691	5691	12"	2" x 2"	Forged	4
5692	5692	18"	2" x 2"	Forged	4
RT25808	RT25808	8"	2" x 2"	Forged	3
TTCT-6	CT-6	6"	2" x 2"	Standard	3
TTCT-12	CT-20	12"	2" x 2"	Standard	3
11029		18"	2 1/2" x 2 1/2"	Forged	5
RT25810		10"	2" x 2"	Forged	3



SOLID SHANK BARS, COMBO TUBES

Part Number	Description
 SBH2	 HE06
 HE12	 HE18
 HH80303	 HH80300
 B1804035	
 45292	 45018
 58102	 TT58102
 10555	 34141
SBH2	Step Bumper Hitch Accept Any 2" Square Ball Mount Or Accessory. Rated For 3500 lbs. Towing Capacity, 350 lbs. Tongue Load
HE06	Extends Hitch 7" Black 22 lbs. 2" Receiver Solid Steel Shanks
HE12	Extends Hitch 14" Black 22 lbs. 2" Receiver Solid Steel Shanks
HE18	Extends Hitch 18" Black 29 lbs. 2" Receiver Solid Steel Shanks
HH80303	REC. ADAPTER FROM 1 1/4" TO 2" 6" LONG WILL NOT FIT IN CLASS 1 RECEIVER BECAUSE OF STOPPER IN HITCH
HH80300	2" To 1 1/4" Receiver hitch Reducer (Requires 5/8" & 1/2" pin - Not Included)
B1804035	includes 1/2" pin 5/8" pin not included
45292	TITAN Hitch Box Extension 24" 6000 lbs. WC & 8000 lbs. WD, 34" 4500 lbs. WC & 6000 lbs. WD
45018	Titan 2 1/2" Extension with 2" Square end 41" 5K WC 7.5K WD 48" 4-6K
58102	Titan Reducer Bushing Reduces Receiver Opening From 2 1/2" To 2" - Class V
TT58102	Tuff Tow Bushing - Unpainted, works with Titan Class V - Reduces Receiver Opening From 2 1/2" to 2"
34141	10,000 lbs. Weld-On Chain Loop - 3/8" Rod
10555	2,000 Weld-On Chain Loop - 3/16" Rod
80307	2" x 2" extension 3.5K



SUPER TRUSS



SUPER HITCH

C

SUPER TRUSS		SUPER HITCH	
Part #	Description	Part #	Description
TLE1521	SUPER TRUSS 21 " 750 / 7,500 1,400 / 14,000	TLC1204	GM 01-07 2500 HD LONG BED 3500 HD EXCLUDES NEW BODY STYLE
TLE1524	SUPER TRUSS 24 " 750 / 7,500 1,400 / 14,000	TLC1205	GM 2008 2500 HD LONG BED 3500 HD INCLUDES NEW BODY STYLE
TLE1528	SUPER TRUSS 28 " 750 / 7,500 1,400 / 14,000	TLC1206	2008 2500 HD LONG BED 3500 HD EXCLUDES NEW BODY STYLE
TLE1532	SUPER TRUSS 32 " 750 / 7,500 1,400 / 14,000	TLD1102	2008 DODGE 2500 HD 3500HD SHORT BED WFACTORY IN- STALLED HITCH
TLE1536	SUPER TRUSS 36 " 750 / 7,500 1,400 / 14,000	TLF1002	99-08 F250 / F350 SHORT & LONG BED
TLE1542	SUPER TRUSS 42 " 750 / 7,500 1,400 / 14,000 SUPER TRUSS 21 " 750 / 7,500 1,400 / 14,000		
TLE1548	SUPER TRUSS 48 " 750 / 7,500 1,400 / 14,000		

C

Solid Steel Hitch Bars

- Made from hot rolled steel for maximum strength
- Rounded corners for versatility to fit all 2" x 2" receivers



Part #	Finish	Length	Description
CUD-29	raw	10"	Solid steel square bar
CUD-30	raw	12"	Solid steel square bar
CUD-31	raw	14"	Solid steel square bar
CUD-32	raw	16"	Solid steel square bar
CUD-33	raw	18"	Solid steel square bar
CUD-34	raw	20"	Solid steel square bar
CUD-35	raw	22"	Solid steel square bar
CUD-36	raw	24"	Solid steel square bar



E-911



E-9



E-13

Receiver Tubing

- Each tube is sized and punched to fit all 2" & 1 1/4" Ball Mounts and accessories

Part #	Finish	Size	Description
CUE-911	raw	1 1/4" x 1 1/4"	6" rec. tube
CUE-912	raw	1 1/4" x 1 1/4"	12" rec. tube
CUE-913	raw	1 1/4" x 1 1/4"	24" rec. tube with 1/2" reinforcing collar
CUE-9	raw	2" x 2"	6" rec. tube
CUE-10	raw	2" x 2"	9" rec. tube
CUE-11	raw	2" x 2"	12" rec. tube
CUE-12	raw	2" x 2"	18" rec. tube with 1/2" reinforcing collar
CUE-13	raw	2" x 2"	24" rec. tube, with 1/2" reinforcing collar
CUE-14	raw	2" x 2"	36" rec. tube, with 1/2" reinforcing collar
CUE-15	raw	2" x 2"	48" rec. tube, with 1/2" reinforcing collar
CUE-2510	raw	2 1/2" x 2 1/2"	10" rec. tube



Weld-On Hitch Box

- 2" ID square opening with collar for custom fabricating hitches
- Tubing sized for easy insertion of ball mounts

Part #	Finish	GTW/TW	Description
CUE-17	raw	5,000/500	Weld-on hitch box



Reinforcement Collar

Part #	Finish	Description
CUF-7	raw	3" x 3" x 1/2" wide w/ 1/4" wall for reinforcing 2 1/2" x 2 1/2" receiver tube

C



Quality since 1946



BH81780

Part #	Ball Size	T/W	GTW	Disc
BUYERS BH81780	*1 7/8"	3,000 lb	16,000 lb	BUYERS Combination Pintle Hook/ball Hitch, Replaceable Hitch Balls.
BH82000*	2"	3,000 lb	16,000 lb	*Includes bolt kit B8520
BH82516	*2 5/16"	3,000 lb	16,000 lb	
B8520	Bolt Kit, Poly bagged			(Lock washers and nuts, Do not use with PH20 4 bolts,)
RB1780	1 7/8			Buyers Replacement Balls Buyers Replacement Balls Buyers Replacement Balls Buyers Replacement Nut } 1 1/8" Diameter Shank
RB2000	2"			
RB2516	2 5/16			
RBNUT	All capacities limited to Reciever Hitch			
BH102000	2"	4,000 lb	20,000 lb	
BH102516	2-5/16"	4,000 lb	20,000 lb	

*RB10200 Replacement Ball Chrome

*RB102516 Replacement Ball Chrome

Part #	Ball Size	T/W	GTW	Disc
63010	1 7/8"	3K	10K	Pintel Combo
63011	2"	3K	10K	Pintel Combo
63012	2 5/16"	3K	10K	Pintel Combo
63017	1 7/8"	Replacement Ball		
63018	2"	Replacement Ball		
63019	2 5/16"	Replacement Ball		
63020		Pin Assembly		
63021		Adjustable Lunette		
63022		Lunette Ring		
63023		Lunette Eye Kit		



B8525	MOUNTING HARDWARE PH20, BH102516, BH102000 4@9/16 X 2" GRD 8 NUTS & LOCK WASHERS
-------	--

Part #	Description
B1809040	1/2" STEEL FAB HITCH PLATE PRE DRILLED FOR PINTLE AND ELECTRICAL
1801055	HITCH, 10,000 LBS, SERVICE BODY, LONG. BUYERS
1801120	Reciever hitch for trailer accessories 2"

C PINTLE HOOKS, PINTLE HOOK MOUNTS

Part #	T/W	GTW	BUYERS Brand Description
PH5	2,000 lb	10,000 lb	Shipped Individually Boxed
PH8	3,200 lb	16,000 lb	Include Mounting Information.
PH15	6,000 lb	30,000 lb	Forged Alloy Steel, fits 2" to 3" I.D. With 1 1/4" to 1 5/8" Diameter Section
B8525			Bolt Kit use with PH20 Only
PH20	8,000 lb	40,000 lb	Steel Rigid Type, fits 2" to 3" I.D. With 1 1/4" to 1 5/8" Diameter Section
B8530			Bolt Kit use with PH45 Only
PH45	16,000 lb	90,000 lb	Cast Alloy Material with One Hand Coupling Latch Locks Into Place When Closed Down. Fits Drawbar Eye 2 3/8" To 3" ID #B8530 Bolt Kit

B8520 Bolt kit required



PH15

0070055

Pin & Lanyard PH45

45-Ton Air Compensated Pintle Hook

Features a "double-safe" locking system with a lock/clasp/impact arm interacting design that combine to prevent release of the eye when air pressure is applied.
The Air Compensated Pintle Hooks must be used with a brake chamber.

- P45AC4K
- P45AC4
- P45AC4BK
- BC45T24
- P45ACH
- P45ACHK

- 45 Ton Pintle Hook Kit, Air Compressed
- 45 Ton Air Comp. 4 Bolt
- Brake Chamber Bracket
- Type 20 Brake Chamber
- 45 Ton Air Compensated Pintle Hook
- 45 Ton Pintle Hook Kit



P45AC4



P45AC4K



BC45T24



P45AC4BK

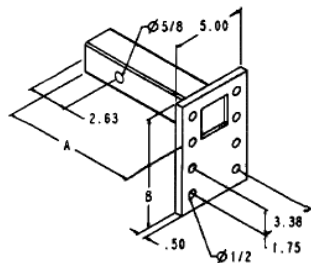

PM25612



PM84

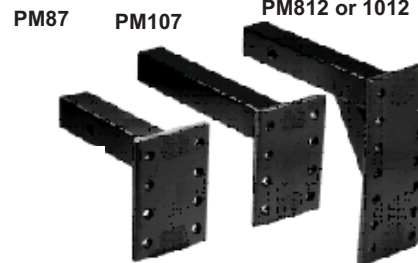

PM87

PM107

PM812 or 1012

PINTLE HOOK ADAPTER MOUNTS

Converts Max-Frame, Max-E-Loader and Ultra Frame Receivers for Use With Pintle-Type Trailers, Quickly and Easily. Provides Mounting for Both Ball and Pintle and Rigid Type Pintle Hooks. Pin and Clip Must be Ordered Separately.

Part #	T/W	GTW	Brand	Dimensions			Disc
				Shank	Height	Width	
45156	1200	12000	TITAN	11"	6"	5"	4 Hole Set 2 1/2" Reciever Black Hollow
PM84	1000	10,000	BUYERS	9"	3 3/4"	5"	2 Hole Set Finish Black Paint
PM87	1000	10,000	BUYERS	9"	7 1/2"	5"	4 Hole Set Finish Black paint
PM107	1000	10,000	BUYERS	10 1/4"	7 1/2"	5"	4 Hole Set Finish Black paint
PM812	1000	10,000	BUYERS	12 1/4"	12 1/2"	5"	7 Hole Set Finish Black Paint
PM1012	1000	10,000	BUYERS	14 1/2"	12 1/2"	5"	7 Hole Set Finish Black paint
PM25612	16,000	16,000	BUYERS	12"		5"	8 Hole Set 2 1/2" Reciever Black.



63056



63058

63056 Pintle Mount 3 hole set 6K GTW Hollow

63057 PINTLE MOUNT 4 HOLE SET 12K GTW SOLID



63057



63059

63058 Pintle Mount 7 Hole Set 8K GTW Solid

63059 Pintle Mount 4 Hole Set 12K solid

Forged Alloy Steel Drawbars

- Flat design allows this drawbar to bolt quickly and easily to a trailer tongue

Part #	Eye dia.	GTW lbs.	Description	Dimensions
CUE-51	3"	22,000	3" I.D. eye flat drawbar	7 bolt 3" x 13" 1.62 flat bar



Forged Alloy Steel Drawbars with Nuts

- Forged from alloy steel
- Available with two different size "Tow Rings"
- Most popular models for heavy equipment trailers
- The single stud is easily installed and eliminates any need for a swivel type pintle hook

Part #	Eye Dia	GTW lbs.	Description	Dimensions
CUE-52	2 1/2"	15,000	2 1/2" I.D. tow ring w/nut, cotter, pin & washer	5 1/2" O.D. x 3 1/4" long
CUE-53	3"	45,000	3" I.D. tow ring w/nut, cotter, pin & washer	6 1/4" O.D. x 4 1/2" long



Forged 4 Bolt Mount Style Drawbars

- Forged one piece construction designed for safety and strength
- Commonly used on heavy duty trailers for over-the-road use
- Smooth back plate for flush mounting to the hitch plate

Part #	Eye Dia	GTW lbs.	Description	Dimensions
CUE-55	2 1/2"	35,000	Forged 2 1/2" I.D. eye square base	4 bolt pattern 6" square base
CUE-56	3"	60,000	Forged 3" I.D. eye square base	4 bolt pattern 6" square base



Adjustable Eye

- One piece forged eye and formed steel bracket
- Commonly used on lighter duty trailers up to 12,000 lbs
- Several different adjustment heights when level trailering is a must

Part #	Eye Dia	GTW lbs.	Description	Dimensions
CU E-60	3"	12,000	Forged 3" I.D. eye adjustable base	2" bolt Pattern spread adjustable eye
CU E-61	N/A	N/A	3 Position channel only	3 1/2" wide by 6" height
CUE-62	N/A	N/A	Bolt & nut kit	N/A
CU E-63	3"	12,000	Forged 3" I.D. eye kit w/3 position channel	3 1/2" x 6" channel w/3" I.D. adjustable eye
CUE-64	3"	12,000	Forged 3" I.D. eye kit w/5 position channel	3 1/2" x 6" channel w/3" I.D. adjustable eye
CUE-65	N/A	N/A	5 position channel only	3 1/2" x 10" channel w/3" I.D.
CU E-66	3"	24,000	Forged 3" I.D. eye adjustable base	2" bolt Pattern spread adjustable eye



E-63



Combination Ball & Pintle Hooks

- Drop forged
- Changeable ball with a hard chrome surface
- Lynch style safety pin

Part #	TW	Pintle Cap	Ball Cap	Finish	Description
CUE-18	NA	16,000	6,000	powder coat	1 7/8" ball and pintle
CUE-19	NA	16,000	10,000	powder coat	2" ball and pintle
CUE-20	NA	16,000	12,000	powder coat	2 5/16" ball and pintle



Replacement Balls for Pintles

- Drop forged with a hard chrome finish
- Fine threads, a self securing nylock nut
- 1 1/4" diameter shank for maximum strength

Part #	TW	Pintle Cap	Ball Cap	Description	For Hole Dia.
CUE-18R	NA	NA	6,000	1 7/8" replacement ball for pintle	1 1/4"
CUE-19R	NA	NA	10,000	2" replacement ball for pintle	1 1/4"
CUE-20R	NA	NA	12,000	2 5/16" replacement ball for pintle	1 1/4"
CU E-118R	NA	NA	6,000	1 7/8" replacement ball for pintle	1 1/8"
CU E-119R	NA	NA	10,000	2" replacement ball for pintle	1 1/8"
CU E-120R	NA	NA	12,000	2 5/16" replacement ball for pintle	1 1/8"



Regular Pintle Hooks

- Most commonly used in construction and agricultural applications
- Drop forged
- Comes complete with a lynch style safety pin

Part #	Vert. Load	GTW	Finish	Description
CUE-21	2,000	10,000	powder coat	regular pintle
CUE-22	4,000	20,000	powder coat	regular pintle
CUE-210	6,000	30,000	powder coat	regular pintle
CUE-30	12,000	60,000	powder coat	30 Ton pintle

CURT Adjustable Pintle Mounts

- For use with receivers with 2" ID. openings
- Solid steel 2" x 2" shank
- 1/2" plate

Part #	GTW	Finish	Holes	Description
CUE-23	10,000	powder coat	4 pair	7" plate, 8 1/2" shank, Pintle mount
CUE-24	10,000	powder coat	4 pair	7" plate, 10 1/2" shank, Pintle mount
CUE-241	10,000	powder coat	7 pair	13" plate, 12 1/2" shank, Pintle mount
CUE-242	10,000	powder coat	7 pair	13" plate, 14 1/2" shank, Pintle mount
CU E-230	NA	NA	NA	Bolt Kit for pintle mounts includes: • 4 Grd.8 Hex Head Bolts (1/2"-13) • 4 Grd.8 Hex Nuts (1/2"-13) • 4 Grd.8 Lock Washers(1/2")



C PINTLE EYES RECEIVER MOUNT



DROP FORGED RECEIVER MOUNT PINTLE HOOK

Single Piece Shank Designed to Fit 2 X 2 Receiver Tubes
Teatherd Locking Pin

Part #	T/W	GTW	Disc
RM5P	2,000 lb	10,000 lb	Receiver Mount Pintle Hook

RECEIVER MOUNT COMBINATION BALL HITCH

Single Piece Shank Designed to Fit 2 X 2 Receiver Tubes
Other size replacement balls available

Part #	T/W	GTW	Disc
RM62000	2,400 lb	12,000 lb	2" Ball Receiver Mount Combination Ball Hitch
RM62516	2,400 lb	12,000 lb	2-5/16" Ball Receiver Mount Combination Ball Hitch

Replacement Balls Available

Part #	T/W	GTW	Disc
B1802279	2,000	10,000	Tri-Ball Mount w/Pintle Hook, 1-7/8", 2", 2-5/16" Chrome Balls

Part #	T/W	GTW	Draw Bar	Disc
LW10	1,000 lb	10,000	Forged Steel	2.5" I.D. Ring.

Part #	T/W	GTW	Draw Bar	Disc
BDB12503	3,000	15,000	Forged Alloy	2 1/2" I.D. Eye
BDB12492H	9,000	45,000	Forged Alloy	3" I.D. Eye
DBA63022				

Part #	I.D. Ring	O.D.	Ring DIA.	Disc
LW847	3"	6.25"	1 5/8"	Forged Lunette Eye C1035 Steel Forged Ring

Part #	T/W	GTW	Disc
B18128	2,000 lb	12,000	Adjustable Eye Assembly 3 Position Channel, 3" I.D. Eye
16137	2,000 lb	12,000	Adjustable Eye Only
03541		20,000	Pintle Eye 3" ID 6" OD

Part #	T/W	GTW	Disc
B23309	2,000	12,000	2 5/16 ADJUSTABLE W/3 POS CHANNEL same as dt 6794
B23310	2,000	12,000	2 5/16 ADJ W/ 5 POS CHANNEL & BOLT KIT 7 HOLES
Part #	Thickness	Holes	Disc
TNP716625750	3/4"	8-21/32"	Trailer Nose Plate 3 Place 4-1/2 x 4-1/2 Bolt Pattern

Part #	T/W	GTW	Disc
BDB125015	7,000	35,000	2 1/2" I.D. Eye With 1 1/2" Section, Forged 4-Bolt Mount
BDB1385	15,000 lb	60,000	Heavy Duty Forged 4-Bolt Mount 3" I.D. Eye & 1.62" Section
BDB1250590			4 Bolt Mount Zieman Style - 2 1/2" Eye - 6 3/4" x 3" Bolt Pattern

Part #	GTW	Disc
57362	20,000	20K 3 POS 4HOLE CHANNEL ONLY 3/8" THICK
59602	20,000	20K 5 POS CHANNEL ONLY 6HOLE 3/8" THICK

Part #	T/W	GTW	Disc
B8978	2,000	12,000	3 Position Channel Only 7-5/8" overall
B8979	2,000	12,000	5 Position Channel Only W/Weld Gussets 11"
B9020			Buyers Bolt & Nut Kit For Adjustable Channel Grd 8

Some items are special order only!

LOX- ALL STA-PIN

Part Number	A Diameter	B Length	C Length
LX142	1/4"	1-3/4"	2-1/2"
LX143	1/4"	2-1/8"	2-7/8"
LX144	1/4"	3"	3-3/4"
LX5162	5/16"	2-1/4"	3-1/8"
LX5163	5/16"	2-1/2"	3-3/8"
LX5164	5-16"	3-5/8"	4-1/2"
LX382	3/8"	1-1/2"	2-3/8"
LX383	3/8"	2-3/8"	3-1/4"
LX384	3/8"	3"	4"
LX385	3/8"	4-1/8"	5"
LX122	1/2"	1-5/8"	2-5/8"

Part Number	A Diameter	B Length	C Length
LX123	1/2"	2-1/2"	3-1/2"
LX124	1/2"	3-1/2"	4-5/8"
LX126	1/2"	4-1/2"	5-5/8"
LX9163	9/16"	3"	4-1/8"
LX584	5/8"	3-1/2"	4-1/2"
LX586	5/8"	4-1/8"	5-1/4"
LX588	5/8"	6-1/8"	7-1/4"
LX344	3/4"	3-1/2"	4-3/4"
LX346	3/4"	4-1/4"	5-3/8"
LX348	3/4"	6-1/4"	7-3/8"
*LX18	1"	6-1/8"	7-3/8"

The Lox-All Sta-Pin Is A Positive Locking Hitch Pin That Operates Easily Under All Conditions.

FORGED LYNCH PINS

Product Number	A Pin Diameter	B Inside Ring Diameter	C Ring Gauge	D Pin Length
LP8453	3/16"	1-7/16"	STD	1-9/16"
*LP3161	3/16"	1-1/8"	STD	1-1/4"
LP4072	1/4"	1-5/16"	STD	1-3/4"
LP9072	5/16"	1-1/2"	STD	1-3/4"
LP3072	7/16"	1-1/2"	STD	1-3/4"
LP7203	7/16"	1-5/8"	HD	1-15/16"
*LP7204	7/16"	1-7/8"	STD	1-15/16"
222-0057	1/4"			
84-0001	1/4" Snap Pin			

Some items are special order only!

PIN & CHAIN

Part#	Description
P11-C	Pin with Bail & Chain for Pintle 1/2" x 2"

SNAPPER PINS

Part#	Pin Diameter
66060	3/8" x 2-1/2"
66050	1/4" x 2"

CLEVIS DROP PINS WITH CLIP

Part#	Pin Diameter	Usable Length
43085	5/8"	6"
43086	3/4"	6"
66100	1/2"	4-1/2"
66120	7/8"	6-1/4"
66125	1"	6-1/4"

CLEVIS FLIP PINS

Part#	Pin Diameter	Usable Length
43073	1/2"	3 1/2"
43074	5/8"	3 1/2"
43077	1"	3 1/2"

CLEVIS DROP PINS WITH CLIP

Part#	Pin Diameter	Usable Length
43082	5/8"	4 1/2"
43083	3/4"	4 1/2"
43084	1"	4 1/2"

1491DAT 9/32" COUPLER LATCH PIN W/ 6" CHAIN
UPTO 1" WIDE LATCH

LOOP BAIL PINS

JCPIN 5/16" x 2.5" round loop bail pin
BX142 Loop-Lok Pin - 1/4" x 1 3/4" - 2.25" Overall Dia.

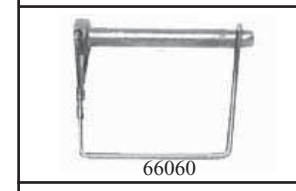
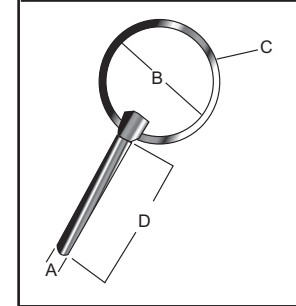
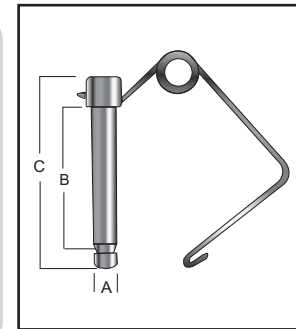

C

LYNCH PINS

* = Special Order/Non-stock

C
COUPLER LOCKS, PIN LOCKS, HITCH LOCKS



1/2" Pin Lock Only

PART#	DESCRIPTION
T2	Trimax 1/2" Lock for 1-1/4" Receiver, Barrel Key Style
5200	1/2" Pin for 1 1/4" Receiver
5470	1/2" Bow Lock

5/8" Lock Only

PART#	DESCRIPTION
T3	Trimax 5/8" Lock for 2" Receiver, Barrel Key Style
T3CAP	Trimax Rubber Cap for T3 lock
1473DAT	1/2" & 5/8" Receiver Lock Sleeved, Fits both 1/2" & 5/8" Pin Holes w/ Removable Sleeve
1480DAT	1/2" & 5/8" Stainless Steel Receiver Lock Sleeved, Fits both 1/2" & 5/8" Pin Holes
5201	5/8" Pin For 2" Receiver, fits up to Class V
MAG200	5/8" Combination Lock; Easy to read Numbers; Free Lock Head Cover
RL63	5/8" Keyed Alike - 6 Pack - Special Order
TBB43	5/8" pin kit Ball end caps
1479DAT	5/8" Barbell Lock
2866DAT	5/8" & 1/2" Sleeved Chrome Steel
SXT5	5/8" LOCK EXTENDED FOR CL V HITCHES STAINLESS STEEL / BARREL KEY STYLE
63217	Pro-Tech Dead Bolt Flat Key

Coupler & Hitch Lock Kits

PART #	DIA.	DESCRIPTION
TM31		Trimax Lock Set for 2" Coupler & Receiver, Keyed Alike
TM32		Trimax Coupler Lock Set, Keyed Alike, T3 & TC2
2848DAT		MasterLock Receiver Hitch Lock & Adjustable Coupler Latch Lock, Keyed Alike
1474DAT	1/2" & 5/8"	Receiver Lock Sleeved, Fits both 1/2" & 5/8" Pin Holes w/ Removable Sleeve With Coupler Lock 9/32" Point of sale Packaged!

PART#	DIA.	DESCRIPTION
RPCLIP		Receiver Pin Clip Only
4666	1/2"	Pin Packaged DT
1376XDAT	5/8" & 1/2"	Fits both 5/8" and 1/2" diameter. Pin and clip
5/8RP	5/8"	Hitch Pin and Clip
4667	5/8"	Pin Packaged DT
63243	5/8"	Pull Pin for 45 Series
KPL200		King pin Lock
55515		CLIP FOR 55010 DRAW-TITE/REESE
55010		HITCH-PIN 5/8 DT/ REESE 2" REC
RH3427		Clip for hitch pin

CURT LOCKS

PART#	DIA.	DESCRIPTION
CUF-5P		Receiver Pin Clip Only
CUF-6	1/2"	Pin Packaged DT
CUF-6P	5/8" & 1/2"	Fits both 5/8" and 1/2" diameter. Pin and clip
CUF-78	5/8"	Hitch Pin and Clip
CUF-140	5/8"	Pin Packaged DT
CUF-20	5/8"	Pull Pin for 45 Series
CUF-500		King pin Lock
CUF-500P		CLIP FOR 55010 DRAW-TITE/REESE
CUF-544		HITCH-PIN 5/8 DT/ REESE 2" REC
CUF-547		
CUF-580		
CUF-582		
CUF-		

Pintle Eye Hook

PART #	DESCRIPTION
4210	Drawbar Lock Rugged Zinc Plated Trailer Locking Device. Fits All 2 1/2" - 3" Lunette Eyes. Accepts Most 1/2" Dia. Padlocks (not included)

Wheel & Spare Locks

PART#	DESCRIPTION
TK100	Trailer Keeper Wheel Lock
262DAT	Spare Tire Nut Lock
4324	SS Tire lock
WC490	WHEEL CLUB LOCK FITS 13" TO 16" wheels upto 28"od tire FROM THE MAKERS OF "THE CLUB"

Part #	Description
TC123	LOCK-COUPLER ADJUSTABLE 3/4 TO 3 1/2" SPAN
TBB4	4 3/8" Long Lock Out Of TBB43 Set, For Adjustable Blmnts. Wyers.
TBB43	TH43 (1) 2 5/8" & (1) 4 3/8" LOCK SET 5/8" hardened steel. The extended pin fits the Rapid Hitch Receiver System by Andersen. Both pins CONE style version and feature triple plated chrome finishes Features patented 1/4 turn technology that cannot be false locked. fit all Class III,

Coupler Locks Only

PART#	DESCRIPTION
TC-1	Trimax Lock Coupler 1/2" to 5/8" Span on Lock, Barrel Style
TC-2	Trimax 2" Coupler Lock 1/4" Rod, Barrel Style
TC-3	Trimax Lock fits Surgebrake Coupler with up to 3 1/2" span
TMC10	Trimax Deluxe Coupler lock fits up to 7/8" span; Chrome lock with Barrel Keys

3008	Fulton Lock fits Lever Lock Couplers with 1/2" Span
2847DAT	MasterLock Adjustable Coupler Lock - Stainless Steel
605DAT	MasterLock 2" Solid Brass Coupler Latch Lock

2848DAT
KEYED ALIKE SET RECEIVER LOCK & ADJUSTABLE COUPLER LOCK SS 5/8 , 1" & 2" WIDE COUPLER

1475DAT
Coupler lock 9/32" dia x 7/8" long shackle

1474DAT
RECEIVER & COUPLER LOCK
SLEEVED REC LOCK FITS BOTH
1/2 & 5/8" COUPLERLOCK 7/8 SPAN 9/32 DIA.

3774XDAT
COUPLER LOCK KIT KEYED ALIKE INCLDS 377DATMOST 1 7/8" & 2" COUPLERS 1475 UP TO 7/8" SPAN & 1473 FITS 5/8 & 1/2" RECEIVERS 3 LOCKS IN A CARRING CASE

3794DAT
Master lock kit

ST30
SPARE TIRE CABLE LOCK W/BARREL KEY



C

COUPLER LOCKS, PIN LOCKS, HITCH LOCKS

* = Special Order/Non-stock

COUPLER LOCKS, PIN LOCKS, HITCH LOCKS

MasterLock Coupler Locks

PART#	DIA.	DESCRIPTION	MasterLock
34	2"	Trailer Coupler Lock, fits most 2" Atwood, Fulton, Dico & Valley	
36	2"	Trailer Coupler Lock, fits Fulton 33-305 / 34-300 / 34-308 / 34-318	
39	1-7/8" -2"	Trailer Coupler Lock, fits Bull Dog and Hammerblow Couplers	



PART#	DIA.	DESCRIPTION	MasterLock
377DAT	1-7/8" -2"	Universal Coupler Lock fits most 2" & 1 7/8" Couplers (No Bulldog product fits)	
378DAT	2 5/16"	Universal Coupler Lock fits most 2 5/16" Couplers (No Bulldog product fits)	
379DAT		all Universal Coupler Lock fits all couplers Except gooseneck.	



Guardian Coupler Locks

PART#	DIA.	DESCRIPTION	Guardian
G56	2 5/16"	Superior Goose Neck Lock Goose Neck Lock Fits Bulldog \ Stallion	



PART#	DIA.	DESCRIPTION	Guardian
G60		Pintle Ring Lock WSL	

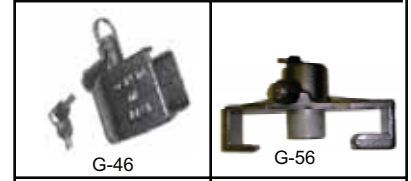

PART#	DIA.	DESCRIPTION	Guardian
G46 WSL	2"	Croft Coupler Lock	



MasterLock Padlocks

PART#	A	B	C	DESCRIPTION	MasterLock
3DAT	9/32"	3/4"	5/8"	Laminated Steel Pin Tumbler Padlock - Keyed Different; 1 9/16" wide body	
3KA	9/32"	3/4"	5/8"	Laminated Steel Pin Tumbler Padlock - Keyed Alike - will special order key numbers	
3008D	9/32"	3/4"	5/8"	Laminated Steel Pin Tumbler Padlock - 4-Pack of No. 3; Keyed Alike	
3T	9/32"	3/4"	5/8"	Laminated Steel Pin Tumbler Padlock - 2-Pack of No. 3; Keyed Alike	
1D	5/16"	15/16"	3/4"	Laminated Steel Pin Tumbler Padlock - Keyed Different	
140D	1/4"	7/8"	13/16"	Solid Brass Padlocks - Keyed Different; 1 9/16" wide body	
312TRI	3/8"	1"	1/2"	Covered Laminated Steel Pin Tumbler Padlock - 3-Pack, blue cover	
175D	5/16"	1"	1"	Combination Padlock - Set your own combination	
40D	3/8"	3/4"	3/4"	Shrouded Padlock - Keyed Different; 2 3/4" wide body	
40KAD	3/8"	3/4"	3/4"	Shrouded Padlock - Keyed Alike	



3DAT, 3KA, 3008D, 3T, 1D



175D



40D, 40KAD



140D, 141D

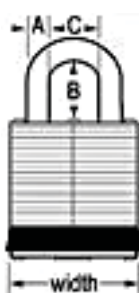

312TRI

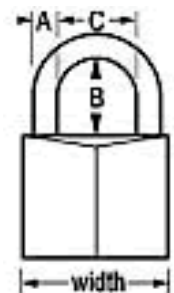
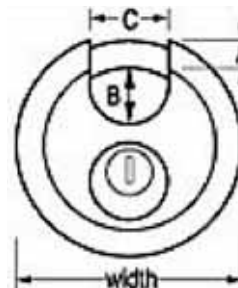

PART#	LENGTH	DIAMETER	DESCRIPTION	MasterLock
614DAT	6'	1/4"	Self-Coiling Black Cable	
8413XDPF	6'	3/8"	Adjustable Locking Cable; Bilingual (English/Spanish) Series Packaging	
8415D	15'	3/8"	Cable only Replacement for 8413	
PART#	Shackle Dia.	DESCRIPTION	MasterLock	
6270	3/8"	Keyed Different; Solid Steel 6-pin W7000 cylinder; 2 7/8" wide body		
770	n/a	Solid Steel Hasp for use with 6270 lock; 9" wide x 4 1/2" high.		
PART#	DESCRIPTION	MasterLock		
430DSPT	Boat Outboard Motor Lock; Keyed Different; Series Packaging	WSL		
PART#	DESCRIPTION	Convertaball		
CK1	CamKnot			
CK2	CamKnot pair, Keyed Alike			
CK3	CamKnot three-pack, Keyed Alike			
PART#	DESCRIPTION			
UMAX100	Trimax Universal Coupler Lock			
UMAX50	Trimax Universal Coupler			
UTL100	Fulton Universal Coupler Lock			
ATVC	Fulton ATV lock kit			

THPXL	
VMAX6	6' VERSA CABLE
185-12001-4	LADDER LOCK FITS 2 LADDERS PADLOCK NOT INCLUDED
TL1020	Draw-Tite Toylock

			
614DAT	8413XDPF	6270	770
			
CK1	430DSPT	UTL100	UMAX100
			
UMAX50	TRAILER BALL COVER 2-5/16" BALL HH42251	BALL COVER-BLACK 1 7/8 - 2" Sold Each 3835	ATV LOCK COMPLETE KIT FRONT & REAR ATVC
TL1020			

COUPLER LOCKS, PIN LOCKS, HITCH LOCKS

* = Special Order/Non-stock

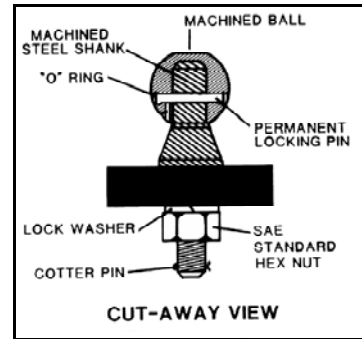
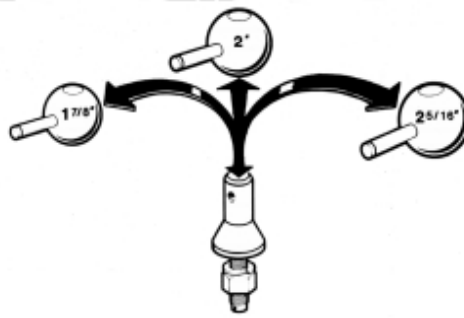
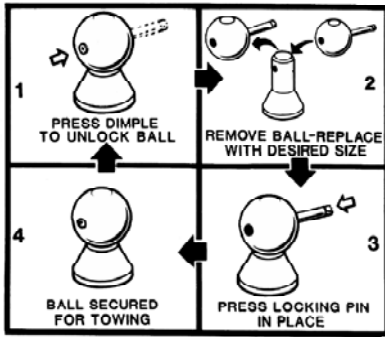

PART#	SIZE	DESCRIPTION	PART#	SIZE	DESCRIPTION
CAB300	1 7/8"	Chromed Ball	CAB100	3/4"	Chromed Shank 3500 lb.
CAB301	1 7/8"	Stainless Steel Ball	CAB101	3/4"	Chromed Shank 3500 lb. Long shank
CAB400	2"	Chromed Ball	CAB104	3/4"	Stainless Steel Shank 5000 lb.
CAB401	2"	Stainless Steel Ball	CAB102	1"	Chromed Shank 8000 lb.
CAB600	2 5/16"	Chromed Ball	CAB105	1"	Super Long Chromed Shank 8000 lb
CAB601	2 5/16"	Stainless Steel Ball	CAB106	1"	Stainless Steel Shank 10,000 lb.
			*CAB107	1"	Super Long Stainless Steel Shank 10,000 lb.

*= Special Order

PART#	DESCRIPTION
CAB700	3/4" Regular Shank 1 7/8" & 2" Balls Chromed
CAB800	3/4" Long shank 1 7/8" & 2" Balls Chromed
*CAB801	3/4" Forged Shank 1 7/8" & 2" Balls Chromed
*CAB802	3/4" Shank 1 7/8" & 2" Balls Stainless Steel
CAB900	1" Shank 1 7/8" & 2" & 2 5/16" Balls Chromed
CAB901	1" Shank 1 7/8" & 2" Balls
CAB902	1" Shank 1 7/8" & 2" & 2 5/16" Balls Stainless Steel
CAB904	1" Shank 2" & 2 5/16" Balls

PART#	DESCRIPTION
CAB005	Shank Cover Red, Gray Or Black
CAB004	3 Ball Storage W/Cover
CAB002	2 Ball Rack

*= Special Order



C CONVERT-A-BALL

Chrome Tow Balls						
* = Packaged Ball: Yes / No						
Ball Size	GTW (lbs)	Buyers	*	Draw-Tite	*	*
1 7/8" x 3/4" x 1 1/2"	2000			63810	N	
				63880	Y	
1 7/8" x 3/4" x 1 3/4"	2000					N
1 7/8" x 3/4" x 2 3/8"	2000			63812	N	
				63882	Y	
1 7/8" x 3/4" x 2 5/16"	2000					Y
						N
						N
1 7/8" x 3/4" x 3 3/8"	2000				Y	
				63814	N	Y
1 7/8" x 1" x 2 7/8"	2000					N
1 7/8" x 1" x 2 1/8"	2000			63884	Y	Y
				63816	N	N
1 7/8" x 1" x 2 3/8"	2000			63818	N	
					Y	
2" x 3/4" x 1 1/2"	3500			63820	N	N
				63887	Y	
2" x 3/4" x 1 3/4"	3500					Y
						N
2" x 3/4" x 2 1/8"	3500			63822	N	
2" x 3/4" x 2 5/16"	3500					Y
						N
2" x 3/4" x 3 3/8"	3500			63824	N	Y
					Y	N
2" x 1" x 2 1/8"	6000			63826	N	Y
				63891	Y	N
2" x 1" x 2 7/8"	6000					Y
						N
2" x 1" x 3 3/8"	6000			63828	N	
					Y	
2" x 1 1/4" x 2 3/4"	8000			63830	N	
2" x 1 1/4" x 2 1/4"	7500					Y
	8000					N
2 5/16" x 1" x 2 1/8"	6000	1802026	N	63832	N	Y
	6000			63894	Y	N
2 5/16" x 1 1/4" x 2 1/8"	10000				N	Y
	10000					N
2 5/16" x 1 1/4" x 2 3/4"	12000				N	
				63896	Y	
				63834	N	
2-5/16" x 1-3/8"	15000				N	
2 5/16" x 1 1/4" x 2 3/4"	10000	1802025	N			
2 5/16" x 1 1/4" x 2 3/4"	14000			63836	N	
2 5/16" x 1 1/4" x 2 3/4"	17000			63838 #	N	

TITAN ball mount & receiver must be used to achieve 17,000 lbs rating.

Additional Accessories

Part Number	Description
B1802090	Nut & Washer 3/4"
B1802091	Nut & Washer 1"
B1802092	Nut & Washer 1-1/4"



A" x B" x C"

C

TOW BALLS



B1802090



B1802092



B1802091

* = Special Order/Non-stock

ZINC TOW BALLS-ASSORTED HITCH BALLS



63811

63833



1802076



2984DAT

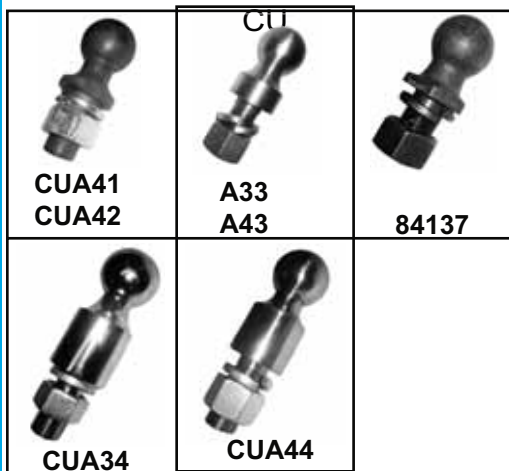

CUA41
CUA42

A33
A43

84137

CUA34

CUA44

Zinc Tow Balls

* = Packaged Ball: Yes / No

Ball Size	GTW (lbs)	Draw-Tite	*	*
1 7/8" x 3/4" x 1 1/2"	2000	63811	N	
		63881	Y	
1 7/8" x 3/4" x 1 3/4"	2000			N
1 7/8" x 3/4" x 2 3/8"	2000	63813	N	
1 7/8" x 3/4" x 2 5/16"	2000			
1 7/8" x 1" x 2 1/8"	2000	63817	N	
1 7/8" x 1" x 2 1/8"	2000	63885	Y	N
1 7/8" x 1" x 3 3/8"	2000	63819	N	
2" x 3/4" x 1 3/4"	2000			N
2" x 3/4" x 1 1/2"	3,500	63821	N	
2" X 3/4" X 1-1/2"	3,500	63888	Y	
2" x 3/4" x 2-3/8"	3,500	63889	Y	
2" x 3/4" x 2 3/8"	3500	63823	N	
2" x 3/4" x 2 5/16"	3500			N
2" x 3/4" x 3 3/8"	3500			Y
2" x 1" x 2 1/8"	6000	63827	N	N
2" x 1" x 3 3/8"	6000	63829	N	
2" x 1 1/4" x 2 7/8"	8000			N
2" x 1 1/4" x 2 3/4"	8000	63831	N	
2-5/16" x 1" x 2-1/8"	6000	63895	Y	
2-5/16" x 1-1/4" x 2-3/4"	12,000	63897	Y	
				Y
2 5/16" x 1" x 2 1/8"	6000	63833	N	N
				N
2 5/16" x 1 1/4" x 2 3/4"	10000		N	
		12000	63835	N

Stainless Steel Tow Balls

2" x 1" x 2 1/8"	6000	63852	Y	N
2 5/16" x 1" x 2 1/8"	6000	63853	Y	
1 7/8" X 1" X 2 1/8"	2000	63851	Y	

Golf Ball Specialty Balls

Part #	Description
1802076	2" x 1" x 2 1/8" Golf Ball Style, 7000 GTW

STEEL REDUCER BUSHING

Part #	Description
HH80100	Reduces a 1" Ball Hole to a 3/4" Hole - Hidden Hitch
HH80106	Reduces a 1 1/4" Ball Hole to a 1" Hole - Hidden Hitch
2984DAT	Ball Bushing Kit 1" to 3/4" & 1 1/4" to 1" - 2 Bushing Vista Pack

ASSORTED HITCH BALLS

Part #	Ball Dia.	Shank Dia.	Shank Length	GTW LB.	Description
CUA33	2"	1"	2 1/8"	6000	1" Rise Chrome
CUA34	2"	1"	2 1/8"	6000	2" Rise Chrome
CUA38	2"	1"	2 1/4"	12000	Chrome Heat Treated
CUA39	2 5/16"	1"	2 1/4"	12000	Chrome Heat Treated
CUA41	2 5/16"	1 1/4"	2 1/4"	30000	
CUA42	2 5/16"	1"	2 1/8"	12000	No Coating
CUA43	2 5/16"	1 1/4"	2 1/4"	25000	1" Rise
CUA44	2 5/16"	1 1/4"	2 1/4"	25000	2" Rise
84137	2 5/16"	1 3/8"	2 1/4"	40000	Forged





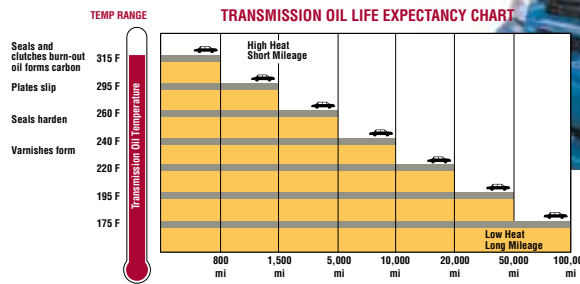

AUTOMATIC TRANSMISSION COOLERS

- Protects Automatic Transmissions in stressful driving conditions
- Easy Do-It-Yourself instructions
- No special tools required
- No cutting of transmission oil lines when transmission line fitting fits are used
- Quick Connect Fittings and Hardware
- Standard and High-Performance Designs Available

Engines and transmissions in today's cars, trucks and sport utility vehicles have been downsized for economy and fuel efficiency and must work harder than ever before. **9 Out of every 10 transmission failures are caused by overheating.** Automatic transmission coolers can increase transmission life by decreasing transmission oil temperature. **Every 20° drop in temperature doubles transmission oil expectancy life.**



TRANSMISSION COOLER APPLICATION CHART

Trailers			
Gross Trailer Weight	Under 2,500 lbs.	2,500-5,000 lbs.	Over 5,000 lbs.
Vehicles			
Compact/ Mid-size cars 	Standard 4670 Hi-Performance 4674		
Full-size/Cars & Pick-up Trucks 	Standard 4671 Hi-Performance 4675	Standard 4672 Hi-Performance 4676	Standard 4673 Hi-Performance 4677
Motorhomes 	Standard 4673 Hi-Performance 4677	Standard 4673 Hi-Performance 4677	Standard 4673 Hi-Performance 4677

STANDARD PERFORMANCE TRANSMISSION COOLERS

All Draw-Tite Automatic Transmission Oil Coolers Fit American and Import Vehicles with Automatic Transmissions and Include:

- Exclusive Aluminum Inner Turbulator Design Swirls Oil Continuously for Maximum Cooling Surface Contact and Cooling Efficiency
- Applications Available for all Domestic and Foreign Cars, Trucks, SUVs and RVs



Standard Performance Design

Part No.	Qty.	Case Lot	Vehicle Applications	Dimensions			Cooling Range	Price
				Thick	Width	Length		
4673	1	6	Full Size Cars or Pickups Towing Over 5,000 lbs.	¾"	10"	15½"	Extra Heavy Duty	

HIGH PERFORMANCE TRANSMISSION COOLERS

- Stacked Plate Construction and Brazed Aluminum Technology for Maximum Strength Cooling Efficiency and Oil Flow Rate
- Applications Available for all Domestic & Foreign Cars, Trucks, SUV's & RV's



Hi-Performance Design

Part No.	Qty.	Case Lot	Vehicle Applications	Dimensions			Cooling Range	Price
				Thick	Width	Length		
4674	1	6	Compact/Mid-Size Cars	¾"	11"	4"	Light Duty	
4675	1	6	Full Size Cars & Trucks, Towing Under 2,500 lbs.	¾"	11"	5½"	Medium Duty	
4676	1	6	Full Size Cars & Trucks, Towing 2,500-5,000 lbs.	¾"	11"	7¾"	Heavy Duty	
4677	1	6	Full Size Cars, Trucks & Motorhomes, Towing Over 5,000 lbs.	¾"	11"	9¾"	Extra Heavy Duty	

TRANSMISSION COOLERS

TRANSMISSION COOLER INSTALLATION ACCESSORIES

TRANSMISSION LINE FITTING KITS

- Kits for Most Popular Applications
- Fittings Thread Directly to Fluid Reservoir on Radiator
- Prevents the Need to Cut Transmission Oil Lines

Part No.	Hayden Model No.	Description	Case Qty.	Lot	Price
4681	250	Quick Connect Coupler. Use With $\frac{3}{16}$ " Factory Cooler Fittings Male and Female - No Need to Cut the Line (Included in Kits 4670 Thru 4677)	1	24	
4683	252	Ford Transmission Line Fitting Kit for Use on 1983 & Later Model Ford, Mazda, Mercury and Lincoln Models With Snap-in, Deep Thread or $\frac{3}{8}$ " NPT Fittings	1	24	
4891	390	1991-04 GM & 1987 & Earlier Model Jeeps With $\frac{3}{8}$ " - 18 Inverted Flare Fittings	1	24	
4892	391	1988 and Later Model Jeeps With $\frac{3}{8}$ " - 18 S.A.E 45° Flare Fittings.	1	24	
4893	392	1994-99 Dodge Trucks and Vans and 1988 and Later Model Jeeps With Quick Disconnect Fittings	1	24	
6441	394	1983 and Later Ford Cars & Trucks, $\frac{1}{2}$ " - 20 Inverted Flare, Recessed Thread	1	24	
6442	395	1987 and Later Ford Trucks, $\frac{3}{8}$ " - 18 Inverted Flare, Recessed Thread	1	24	

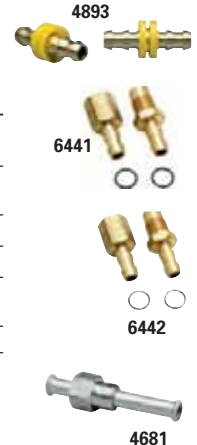

TRANSMISSION COOLER HOSE

Part No.	Description	Qty.	Price
3132	Transmission Oil Cooler Hose, $\frac{1}{2}$ " I.D., 25' Long	1	
4682	Transmission Oil Cooler Hose, $\frac{1}{2}$ " I.D., 4 1/2' Long	1	



QUICK CONNECT MOUNTING KIT

- Secures Transmission Cooler to Vehicle Radiator

Part No.	Description	Qty.	Price
4680	Quick Connect Mounting Kit, Includes: 4 Nylon Mounting Rods, Locking Nuts & Rubber Pads.	1	



TRANSMISSION COOLERS FITTINGS





KK370SB

ASSEMBLE REQUIRED AND SHIPPING CHARGES MAY APPLY

KarKaddy3 model KK370SB will tow almost any vehicle without difficult, time consuming adjustments to axles or ramps. This means no bolts to tighten and no heavy components to reposition.

Attached "SURE-GRIP" Low Profile Loading Ramps and Platforms. Formed and punched traction holes eliminate areas where dirt and moisture can cause corrosion problems.

Make trouble-free turns with Auto-Steer cornering.

Tilt-bed frame with positive automatic relatch locking mechanism for fast, easy loading.

Sealed bearing hub is so trouble-free, we back it with a 3 YEAR Unlimited Warranty NEVER REPACK WHEEL BEARINGS AGAIN.

Surge brakes included

Computerized factory balanced 14" wheels and radial tires.

Full coverage polyethylene fenders with protected, sealed lights.

Polyester basket style tie-down straps are safe easy to handle and are secured at three points. Towed vehicle rides on its own suspension.

You need only one hand to operate the wheel tie-down winches.

Attached safety tie-down chains for towed vehicle.

The KK370SB is standard with a hydraulic surge brake system.

Ideal for RV owners who need an economical, dependable auto transport.

Will accommodate front wheel drive standard or automatic transmission vehicles.

Less than 100 lbs. tongue weight, when loaded, for improved ride and handling of tow vehicles. Ideal for towing by mini motorhomes.

Tilt-bed frame for fast, easy loading. Positive locking mechanism on tilt-bed does not require a separate loose pin.

Attached loading ramps. No ramps to lift or store.

Auto-Steer cornering for problem-free turns.

Lower center of gravity for towed vehicle improves stability

Dual safety chains for towed vehicle are standard.

C

KAR KADDY 3

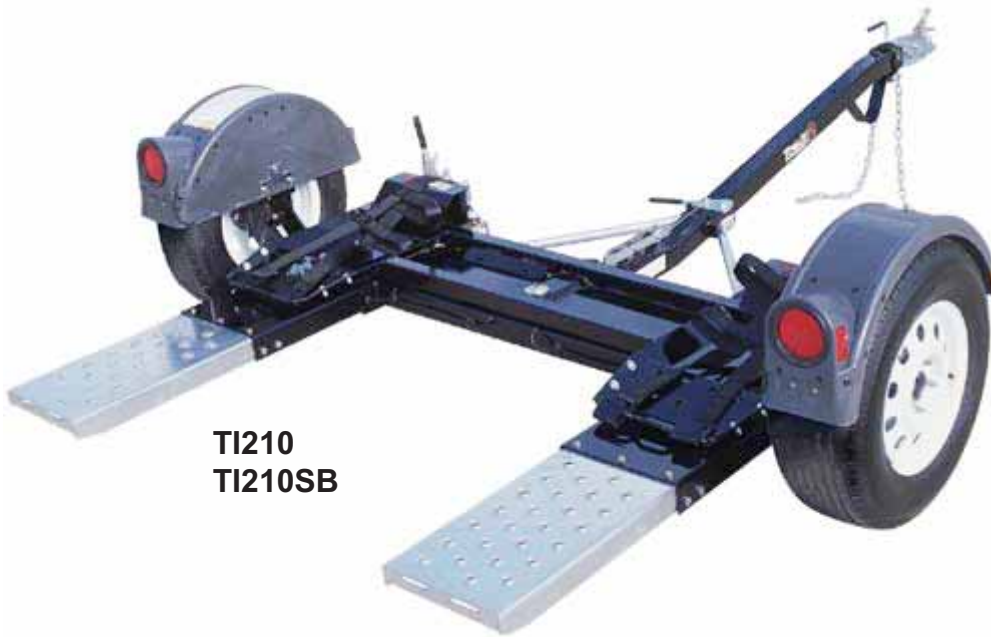

TI210
TI210SB

ASSEMBLE REQUIRED AND SHIPPING CHARGES MAY APPLY

Where quality and economy meet. An economical alternative to the KarKaddy3™. 8 ft. configuration only.

Top swivel platform.

Low profile ramps.

Sealed bearing hub is so trouble-free, we back it with a 3 YEAR Unlimited Warranty
NEVER REPACK WHEEL BEARINGS AGAIN.

Available with or without surge brakes.

TI210 - without brakes.

TI210SB - with brakes.

Does not include freight or dealer assembly / prep.



KK460SS - 8.5' Folding Kar Kaddy

ASSEMBLE REQUIRED AND SHIPPING CHARGES MAY APPLY

The Kar Kaddy™ SS will tow almost any vehicle, large or small, without difficult, time consuming adjustments to axles or ramps. This means no bolts to tighten and no heavy components to reposition.

Standard Features:

Hydraulic surge brake system provides safe, controlled stopping.
A durable galvanized finish with custom chrome wheels and raised white letter radial tires make this tow dolly one you'll be proud to use for years to come.
Will accommodate front wheel drive standard or automatic transmission vehicles.
Less than 100 lbs. tongue weight, when loaded, for improved ride and handling of tow vehicles. Ideal for towing by mini motorhomes.
Trouble free sealed bearing hub with 3-year unlimited warranty.

Tilt-bed frame provides fast, easy loading. Positive locking mechanism on tilt-bed does not require a separate loose pin.
Attached "SURE-GRIP" loading ramps provide a safe loading traction.
Auto-steer cornering makes turns problem free.
Lower center of gravity for towed vehicle improves stability.
Dual safety chains for towed vehicle are standard.
Wheel jack to help move the dolly when not loaded.
LED lights give more illumination and longer life.

DOES NOT INCLUDE FREIGHT OR DEALER ASSEMBLY/PREP

Views on next page

C

KAR KADDY



KAR KADDY 3



Unfolded KarKaddy™ SS length is 133"
Many RV park lots are not deep enough
to accommodate your motorhome and
tow dolly.



A folded KarKaddy™ SS length is 67"
By using only half the space, you can
fit both your motorhome and tow dolly
comfortably in almost any RV lot. Or
you can store your tow dolly in front of
your car in your garage at home.

GT300

Features:

- Heavy-Duty Frame
- Pivoting Fifth-Wheel Design
- Attached Loading Ramps
- Ratchet Tie-Down Winches
- Transport Vehicle Safety Chains
- Synthetic Full Fenders
- Tilting Ramps
- Rubber Mounted Lights
- Maintenance Free Hub & Spindles
- Factory Balanced Radial Tires
- 2" Ball Coupler

DEMCO

- Sealed Hubs
- Poly Fenders
- Galvanized
- Torsion Axle
- 3500 lb. Capacity

Towed Tread Width of 42" Min & 74" Max

**Available with Optional Surge Brakes at Extra Cost*

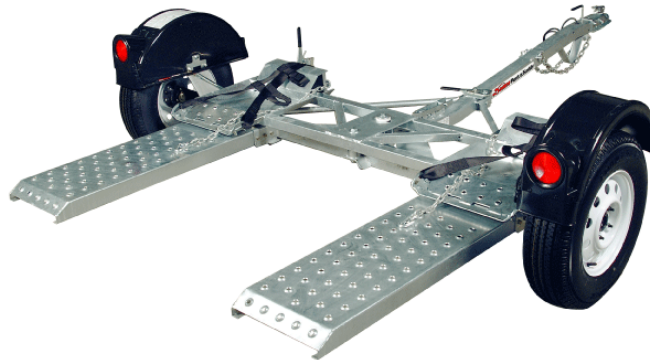

ASSEMBLE REQUIRED AND SHIPPING CHARGES MAY APPLY



Never repack wheel bearings again!
All units feature the maintenance free hub with sealed bearings.



3-Point polyester bolt-on tie-down straps



Zinc plated ratchet winches.
30% more gripping power than conventional ratchets.



3-Point polyester bolt-on tie-down straps with easy to attach J-hooks.



Tilt-bed latch in the loading position.



Tilt-bed latch in the locked position.

See next page for specifications

C

DEMCO GT300

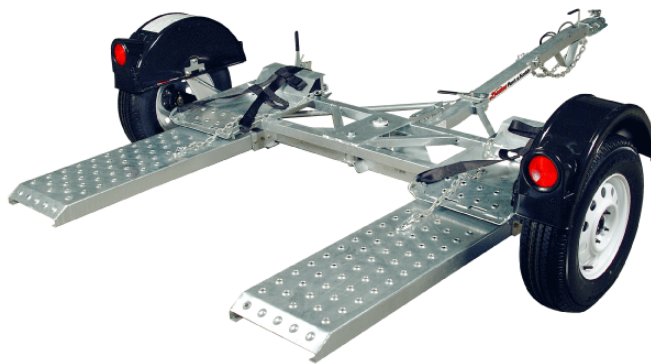

GT300

Torsion Axle Rent-a-Kaddy GT (Galvanized) Series

GT300

Overall Width:	101"
Overall Length:	143" (with ramps)
Wheels:	14 x 5.5
Radial Tires (BSW):	ST205/75R14 "C"
Weight:	700 lbs.
GVWR (unit weight plus maximum carrying capacity):	3500 lbs.
Towed Vehicle Tread Width (minimum - maximum):	42" - 76"
Maximum Towed Vehicle Body Width:	76"
Axle Capacity:	3500 lbs.
Coupler Rating:	6000 lbs.
Surge Brakes and Actuator:	No
Total Towed Vehicle Weight:	
(front wheel drive)	4500 lbs.
(rear wheel drive)	4800 lbs.

C

DEMCO GT300

ASSEMBLY PARTS BREAKDOWN and OPTIONS

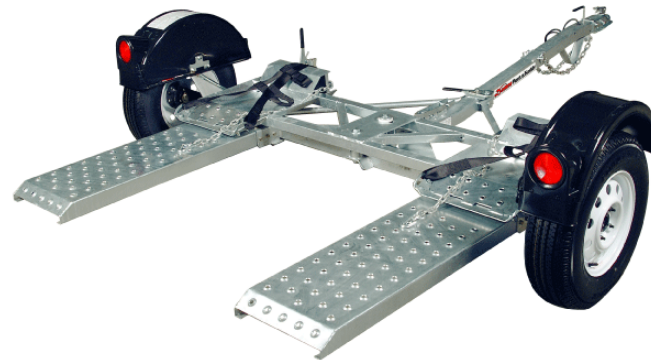
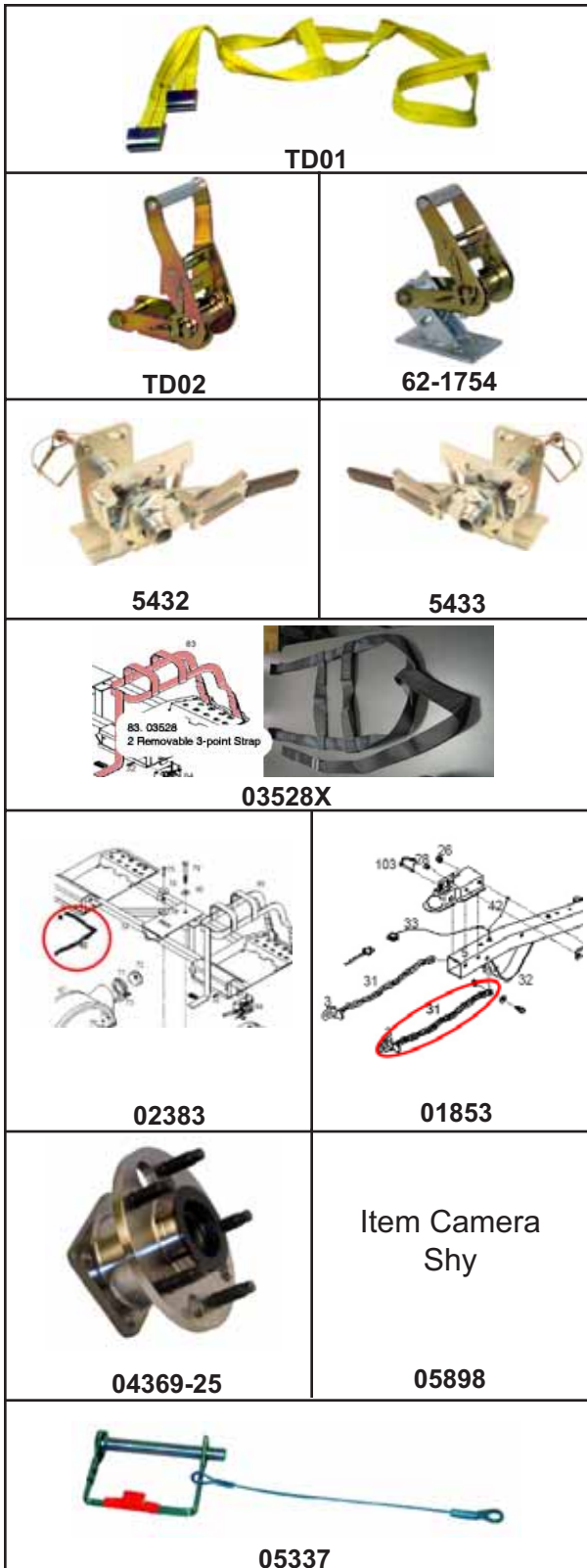

Part Number	Description
TD01	-Tow Dolly Strap -Un-even Double hook to fit multi-size tires. -Yellow -10,000 lbs Rating
TD02	-Tow Dolly Ratchet Buckle
62-1754	-Tow Dolly Ratchet Buckle -Galvanized mount
5432	LH RATCHET WINCH ASY
5433	RH RATCHET WINCH ASY
03528X	GT200 TOWDOLLY 15" 3 POINT STRAP W FLAT HOOK WILL WORK WITH 700-15 & OTHERS
04369-25	GT200 TOW DOLLY SEALED HUB SPINDLE 5 ON 115MM FIT BC NDH SOLD EACH.
01853	GT200 FRONT SAFETY CHAIN 24" LONG
02383	GT200 36" CAR SAFETY CHAIN HOLD DOWN FOR DOLLY
05898	GT200 TOWDOLLY 3 PT NON REMOVEABLE STRAP RENTAL STYLE SO YOU DONT LOSE THE STRAP
05337	GT200 TOWDOLLY RATCHET LOCK PIN W/CABLE

DEMCO GT300 ASSEMBLY PARTS & OPTIONS

* = Special Order/Non-stock

DEMCO GT300 ASSEMBLY PARTS & OPTIONS

REF. NO.	PART NO.	QTY.	DESCRIPTION
1.	07167	1	Spring Sleeve
2.	02189	1	Hand Grip
3.	07426	4	Safety Hook Retainer
4.	00205	12	7/16" Flatwasher
5.	02771	6	7/16"-14 UNC Nylon Insert Locknut
6.	03379	1	Latch Block
7.	03574	1	Latch Handle
8.	02243	1	Black Vinyl Hand Grip
9.	03381	1	Latch Catch
10.	03382	1	Handle Bushing
11.	00085	6	1/2" Flatwasher
12.	00967	1	1/2"-13UNC x 1-1/4" Hex Head Bolt (Gr.5)
13.	02178	1	1/2"-13UNC Nylon Insert Locknut
14.	05444	1	3/8"-16 UNC x 3/4" Epoxied Hex Bolt (Gr 5)
15.	00059	15	3/8" Flatwasher
16.	05449	1	Spacer Bushing - Stainless Steel
17.	03434	1	5/16"-18 UNC x 5-1/4" Eye Bolt
18.	03433	1	Latch Cable
19.	03435	1	Roll Pin (5/16" x 2-1/4")
20.	03499	1	Latch Spring - Stainless Steel
21.	00007	1	5/16"-18 UNC Hex Nut
22.	04221	1	5/16"-18 UNC x 2-1/2 Hex Head Bolt (Gr 5)
23.	02802	1	5/16"-18 UNC Nylon Insert Locknut
24.	00004	1	5/16" Flatwasher
25.	03769	1	Tongue
26.	04496	1	Coupler
27.	01338	4	1/2"-13UNC x 4-1/2" Hex Head Bolt (Gr.5)
28.	02178	8	1/2"-13UNC Nylon Insert Locknut
29.	02288	1	Lift Handle
-	04017	1	Lift Handle (For Bake Unit)
30.	03503	2	5/8"-11UNC x 1-1/4" Hex Hd. Epoxied Bolt(Gr.5)
31.	01853	2	24" Safety Chain with Hook
32.	01898	6	7/16"-14UNC x 1-1/4" Hex Head Bolt (gr.5)
33.	04785	1	Wiring Harness (Front Half)
34.	04786	1	Wiring Harness (Rear Half)
35.	03394	2	Bracing Strut (8'-3" wide unit)
36.	01254	2	1/2"-13UNC x 1-1/2" Hex Head Bolt (gr.5)
37.	02579	2	Pivot Bushing
38.	07166	1	Tilt Bed Spring
39.	02434	1	5/8"-11UNC x 4-1/2" Hex Head Bolt (gr.5)
40.	02587	1	5/8"-11UNC Nylon Insert Locknut
41.	05933	2	5/8"-18UNF Nylon Insert Locknut
42.	01863	1	5/8" Grommet
43.	01863	2	3/8" I.D. x 5/8" O.D. Grommet
44.	03770	1	Undercarriage
45.	03366	2	Cartridge Insert
46.	03368	2	Thin Cartridge Shim
47.	03500	4	1/2"-13UNC x 1" Socket Hd. Set Screw
48.	03293	1	Forged Arm (Left Side)(No Brake Line Mount)
49.	03359	1	Forged Arm (Right Side)(No Brake Line Mnt.)
50.	05932	2	5/8"-18UNF x 3-3/4" Hex Hd. Bolt (Gr.8)
51.	04369	2	New Departure Hub (5 on 115mm Bolt Circle)
-	02917	-	Replacement 12mm x 1.5 Stud Bolt
52.	02377	8	7/16"-20UNF x 1-1/2" Epoxied Hex Hd Bolt (Gr.8)
53.	09296	2	14" x 5.5" Rim (5 on 115mm Bolt Circle)
54.	04826	2	ST205/75R 14" x "C" Radial Tire
55.	02213	10	12mm zinc Lug Nut
56.	03665	1	Right Upright Wire Protector Tube
-	03662	1	Left Upright Wire Protector Tube
57.	07092	2	48" Ramp
58.	03525	20	7/16"-20UNF x 3/4" Hex Head Bolt (Gr.8)
59.	03724	20	7/16"-20UNF Hex Punch Locknut
60.	03377	2	Wearplate (four hole)
61.	07082	8	1/4"-20 UNC x 1" Flat Hd Torx Cap Screw
62.	02772	8	1/4" Nylon Insert Locknut
63.	04424	2	Back-Up Plate for Fender
64.	00914	4	3/8"-16UNC x 1-1/2" Hex Head Bolt (Gr.5)
65.	03526	2	3/8"-16UNC x 1-1/2" Flat Hd. Hex Socket Bolt
66.	02592	14	3/8"-16UNC Nylon Insert Locknut
67.	04000	1	Right Poly Fender
68.	04001	1	Left Poly Fender
69.	02298	2	22-1/2" Wire Loom
70.	04425	8	Wire Retaining Clip
71.	05447	2	Rubber Mounting Grommet for light
72.	05446	2	Sealed Round Taillight
73.	02313	2	3-Way Plug Pigtail (Taillight)
74.	03773	1	Top Platform
75.	00348	1	1/2"-13UNC x 2-1/4" Hex Hd. Bolt (Gr.5)
76.	02578	1	Metal Pivot Washer
77.	00698	1	Top Pivot Bushing
78.	03370	1	UHMW Pivot Washer
79.	00638	1	3/4"-10UNC x 6" Hex Hd. Bolt (Gr.5)
80.	00492	1	3/4" Flatwasher
81.	02961	1	3/4"-10UNC Nylon Insert Locknut
82.	02383	2	36" Safety Chain with hook
-	04194	-	7/16" "S" Hook for safety chains
83.	03528	2	Removable 3-point Strap
-	02729	2	Buckle (only)

REF. NO.	PART NO.	QTY.	DESCRIPTION
-	04508	4	Amber Fender Reflector (not shown)
-	04804	2	Red Fender Reflector (not shown)
-	01883	6	Electrical Wire Splicer (not shown)
-	05443	2	Cable Hanger for Wire Harness (not shown)
84.	5432	1	Left Ratchet Winch (Plated)
85.	5433	1	Right Ratchet Winch (Plated)
86.	03569	1	Ratchet Frame
87.	03570	1	Left Spool Tube
-	03571	1	Right Spool Tube
88.	03577	1	Heavy Duty External Snap Ring
89.	03574	1	Ratchet Handle
90.	03575	1	Left Ratchet Gear
-	03576	1	Right Ratchet Gear
91.	03666	1	5/16" x 1-1/4" Roll Pin
92.	02243	1	Black Vinyl Hand Grip
93.	05450	1	Winch Pawl
94.	01864	2	Winch Pawl Spring SS
95.	05449	1	Winch Pawl Bushing SS
96.	03572	1	Left Ratchet Pawl Arm
-	03573	1	Right Ratchet Pawl Arm
97.	03578	1	5/16"-18 UNC x 1/2" Shoulder Screw
98.	01998	1	3/16" Flatwasher SS
99.	02002	1	1/4" Flatwasher SS
100.	00062	1	1/4"-20 UNC Hex Nut
101.	04055	1	1/4"-20 UNC x 1" Hex Head Bolt (Gr.5)
102.	00214	1	1/4" Flatwasher
103.	05337	1	Lock Pin w/Cable
104.	35013	1	Tilt Latch Weldment

Please order replacement parts by PART NO. and DESCRIPTION

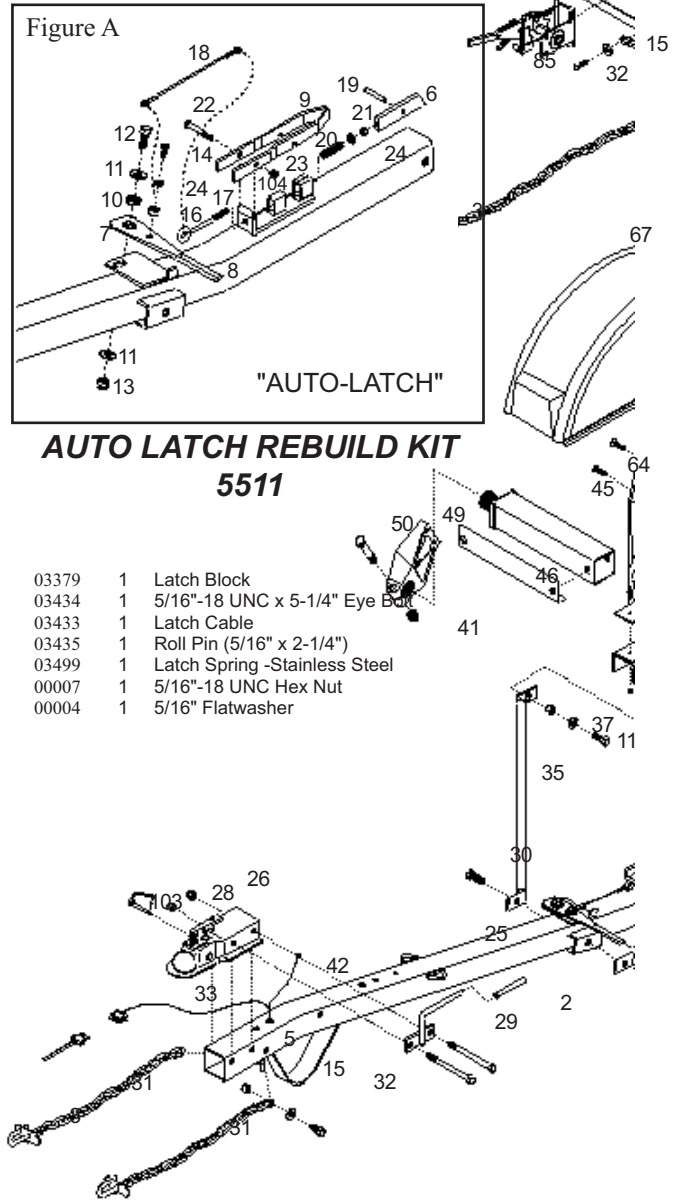

6.	03379	1	Latch Block
17.	03434	1	5/16"-18 UNC x 5-1/4" Eye Bolt
18.	03433	1	Latch Cable
19.	03435	1	Roll Pin (5/16" x 2-1/4")
20.	03499	1	Latch Spring -Stainless Steel
21.	00007	1	5/16"-18 UNC Hex Nut
24.	00004	1	5/16" Flatwasher

Decals

- BH21003 - Decal for Surge Brake Actuator: Red = Don't Tow / Green = Tow
- KKDD21002 - "Rent-A-Kaddy" Decal
- KKDD21007 - Decal Instructions "Rent-A-Kaddy"
- KKNA21007 - "55 MPH Speed Limit" Decal
- KKNR21010 - 55 MPH Max Kar Dolly 6x8
- KKZA21002 - "Made in America"
- KKZA21004 - "Warning: Do Not Back Up"

Left Winch Shown

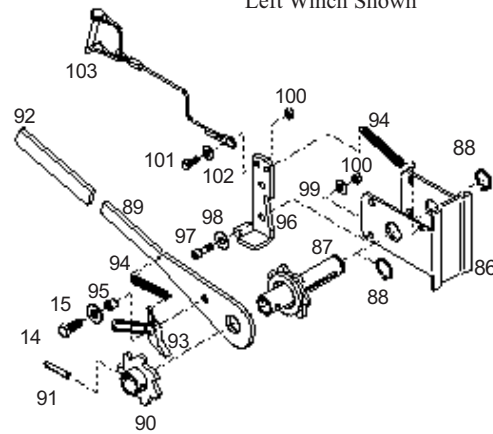

3-Point Non-removable Tie-down Straps Option

REF NO.	PART NO.	QTY.	DESCRIPTION
104	05898	2	Non-Removeable 3-Point Strap w/Buckle
105	05892	4	Tie-Down Bracket
106	00907	8	3/8-16 UNC x 1 Hex Head Bolt (Gr 5)
107	00059	8	3/8 Flat Washer
108	02595	8	3/8-16 UNC Nylon Insert Locknut

Please order replacement parts by PART NO. and DESCRIPTION.

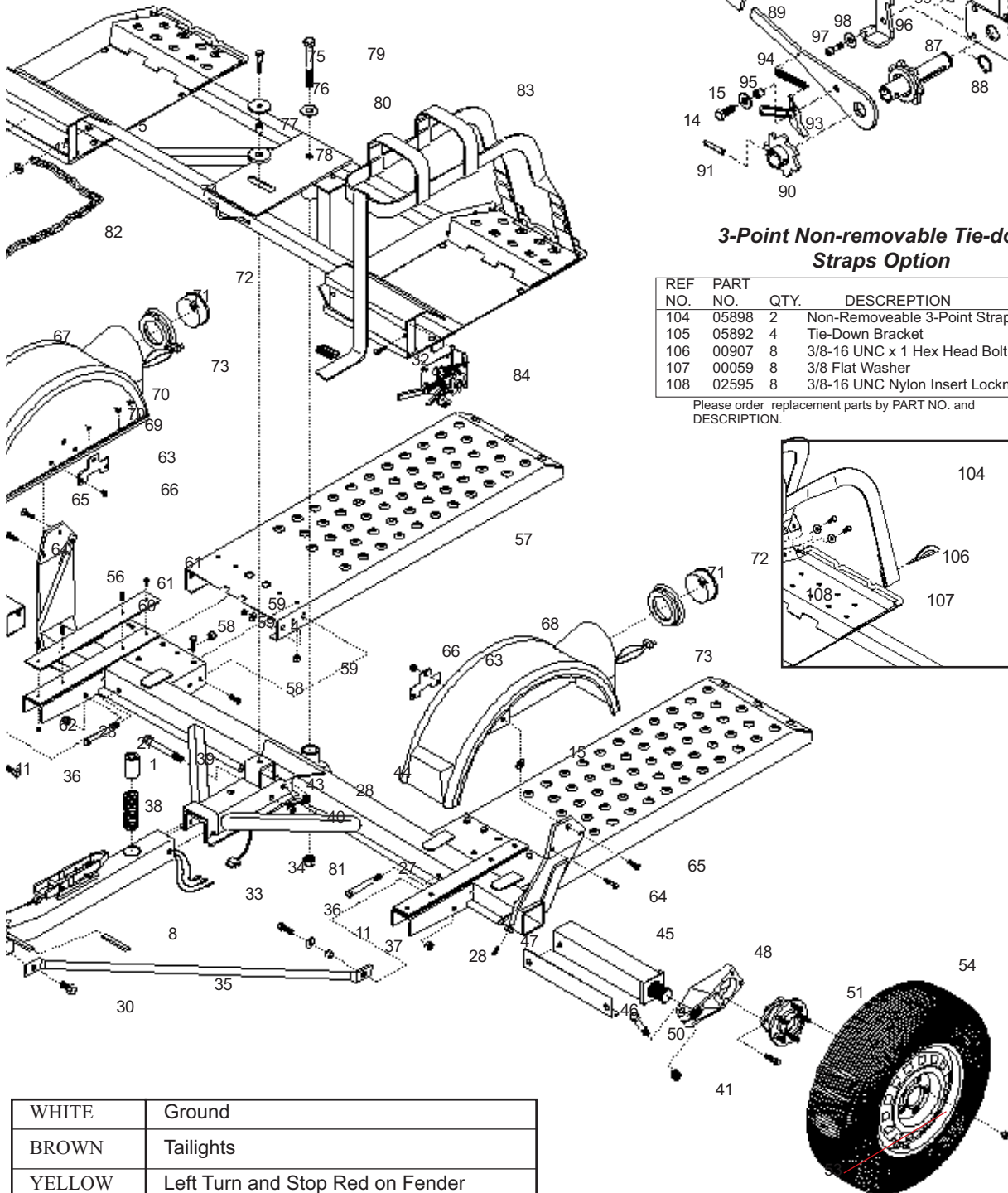
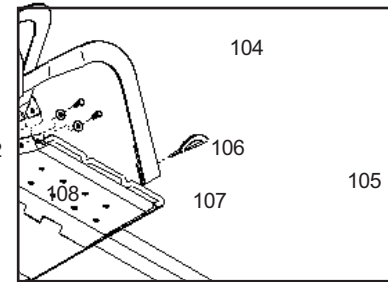

WHITE	Ground
BROWN	Tailights
YELLOW	Left Turn and Stop Red on Fender
GREEN	Right Turn and Stop Red on Fender

DEMCO GT300 ASSEMBLY PARTS & OPTIONS

C

MIRRORS



CA11955

Fast Hitch Mirror

The FastHitch folds easily to a compact size, which stows away nicely in a rear seat storage bin or cargo area toolbox. The view of the CIPA FastHitch from the interior gives the driver a clear, unobstructed view of the hitch and ball. This makes alignment a snap and requires only one



**CA11960
40375**

Universal Towing Mirror

CIPA-USA's new Universal Towing Mirror extends your vision further than any OEM mirror. With a fully adjustable mirror, Adjustable feet, securing clamps, and a tightening knob, the mirror gives you the extended vision you need, without any annoying vibration! With it's aerodynamic and Durable styling, and no tools required to install, this is the perfect mirror for beginning and experienced towers everywhere!

63300
Trailer & Hitch Aligner
DRAW-TITE



**Towing Mirrors
(See Chart)**



**Clip-On Towing
Mirror**

Easily adjustable arms for amny applications. Rubber straps secure clip-on towing mirror to your existing mirror.



CA11950



CA11953	CIPA DUAL-VIEW CLIP-ON TOWING MIRROR
---------	--------------------------------------

**CA11953
7070**

CUSTOM TOWING MIRRORS

Part #	Product Image	Applications & Fits	Years	Fits Over
CHEVY/GMC				
CA10000		GMC/Chevy Pick-Ups & Vans • Fits Chrome Manual mirrors only. • Will not fit the chrome mirrors with black trim	1980-1995	
CA10200 Pair **10201 Left **10202 Right		GMC/Chevy Full Size C/K Pick-Ups Suburban/Yukon/Kodiak/Dually/Tahoe Safari/Astro Vans Cadillac Escalade • Fits both electric & manual black fold-away mirrors. Fits the long, thin mirror that is not attached to an arm	1988-2000 1992-1999 1991-2004 1992-1999	
CA10400 Pair **10401 Left **10402 Right		Chevy Sonoma, S-10 GMC Envoy Isuzu Hombre Chevy Full-size Blazer, Jimmy, Oldsmobile Bravada • Fits electric & manual black mirrors.	1994-1998 1995-1998 1996-1997 1995-2000	
CA10600 Pair **10601 Left **10602 Right		Chevy Venture GMC Silhouette Pontiac Transport	1997-2004 1997-2004 1997-2004	
CA10800 Pair **10801 Left **10802 Right		GMC/Chevy Full Size Pick-Ups, Silverado & Sierra Chevy Tahoe, Suburban, Avalanche GMC Denali, Yukon, Yukon XL Cadillac Escalade • Fits the full black & chrome-cap models, will not fit the full chrome mirrors, or telescopic mirrors	1999-2006 2000-2006 2000-2006 2000-2006	
CA10900 Pair **10901 Left **10902 Right		GMC/Chevy Full Size Pick-Ups, Silverado & Sierra Chevy Tahoe, Suburban, Avalanche GMC Denali, Yukon, Yukon XL Cadillac Escalade • Will not fit telescopic mirrors	2007 2007 2007 2007	
DODGE				
CA10000		Dodge Pickups & Vans • 86-93 Fits both electric & manual chrome mirrors • 1994-95 fits chrome manual mirrors only.	1986-1995	
**10100 Pair **10101 Left **10102 Right		Jeep Grand Cherokee, Grand Wagoneer • Fits both electric & manual black mirrors. • Fits the Grand Cherokees only	1993-1995	
CA10300		Dodge Pick-Ups & Vans • 1994-1997: fits both electric & manual black mirrors. • 1996-1997: fits the chrome electric mirrors. • Will not fit the Dodge Dakotas with black sport mirrors.	1994-1997	
CA10500 Pair **10501 Left **10502 Right		Dodge Ram (2002 - fits 2500 & 3500 only) Dodge Dakota Dodge Durango Dodge Full Size Van • Will not fit 5x7-inch sport mirror.	1998-2001 1998-2004 1998-2003 2000-2003	
CA10700 Pair **10701 Left **10702 Right		Dodge Ram 1500 Dodge Ram 2500 & 3500	2002-2006 2003-2006	
FORD				
CA11000		Ford full Size Pick-Ups & Rangers Chevy S-10 & GM S-15 • Fits the chrome two-point break away style mirrors. • Fits the S-10/S-15 up to 1993 only. • Fits Rangers only up to 1991, style changed in 1992.	1983-1998 1982-1993	
CA11500 Pair **11501 Left **11502 Right		Ford Full Size Pick-Ups Ford Aerostar Van Ford Explorer & Navajo Ford Bronco Ford F-250 & F-350 HD w/ old body style • Fits fully-black, or black w/ chrome cap mirrors. Additional adapter (Part # 11504) needed for Explorer	1992-1997 1990-1997 1988-1995 1992-1996 1997	
CA11600 Pair **11601 Left **11602 Right		Ford F-150/250 Light Duty Pickups (will not fit STX or Lariat models) Ford Expedition, Lincoln Navigator Ford Heritage Edition • Fits both painted and chrome mirrors, does not fit 2004 New-Style Pickups, see #11800	1997-2004 1997-2002 2004	
CA11700 Pair **11701 Left **11702 Right		Ford Full Size Pick-Ups F-250, F-350 & Heavy Duty (manual) F-150 XL (manual) • Will not fit Super Crew models	1997-2002 2000-2001	
CA11800 Pair **11801 Left **11802 Right		Ford F-150 & F-250 Light Duty Pickups (New Style) • Will not fit STX-style mirrors, or Super Crew models	2004-2007	
CA11900 Pair **11901 Left **11902 Right		F-250 & F-350 Super Duty Ford Excursion	1997-2008 2000-2008	

C

MIRRORS

* = Special Order/Non-stock

C

MIRRORS

DT	CIPA				
Part No.	Model No.	Pkg. Type	Description		Price
** 8810	CA 10203	1 Pr. Bagged	Replacement Hardware CA 10200		
** 8811	CA 10002	1 Pr. Bagged	Replacement Hardware CA 10000		
** 8812	CA 10803	1 Pr. Bagged	Replacement Hardware CA 10800		
** 8813	CA 10303	1 Pr. Bagged	Replacement Hardware CA 10300		
** 8814	CA 10503	1 Pr. Bagged	Replacement Hardware CA 10500		
** 8815	CA 11002	1 Pr. Bagged	Replacement Hardware CA 11000		
** 8816	CA 11503	1 Pr. Bagged	Replacement Hardware CA 11500		
** 8817	CA 11603	1 Pr. Bagged	Replacement Hardware CA 11600		
** 8831	CA 10703	1 Pr. Bagged	Replacement Hardware CA 10700		
** 8832	CA 11703	1 Pr. Bagged	Replacement Hardware CA 11700		
** 8833	CA 10803	1 Pr. Bagged	Replacement Hardware CA 10800		
** 8834	CA 10903	1 Pr. Bagged	Replacement Hardware CA 10900		



UNIVERSAL SWING-AWAY

Universal design, fits Chevy, GMC, Ford and many other makes, both left and right hand application. Large 10 1/2" x 7 1/2" mirror head with vinyl cushioned mirror glass. Swing-away arm design and offset mounting on head permits high or low positioning for multiple applications. 820 is black ABS head and epoxy-coated steel arms. 821 features all stainless steel construction. 821C features ABS chrome plated head. Packaged in a full-view clamshell.

Order Numbers	Disc	Pack	Std. Carton
*820	black	Viz Pack	Sold ea 6
821	stainless steel	Viz Pack	Sold ea
*821c	ABS chrome	Viz Pack	6
*831	repl. head black	Viz Pack	6
832	repl. head SS	Viz Pack	Sold ea

UNIVERSAL LOW MOUNT

Universal design, ideal for both full and down-sized pickups and vans, left and right hand application. 8 1/2" x 5 1/2" mirror head is molded from durable, corrosionfree ABS material. Universal, aluminum mounting bracket will fit all door contours. 822 is black and 823 is chrome finish. Packaged in a full-view clamshell.

Order Numbers	Disc	Pack	Std. Carton
822	black	Viz Pack	Sold ea
823	chrome	Viz Pack	Sold ea
835	repl. head black	Viz Pack	Sold ea
*836	repl. head chrome	Viz Pack	6

UNIVERSAL FENDER MOUNT - Sold Each

Bracket assembly fits most passenger car and light truck applications. Stainless steel mirror head and black, epoxy-coated arms are fully adjustable. Rubber tips on the attachment points of the arms prevent damage to vehicle finish. Turnbuckle adjustment for fast and easy installation. Packaged in an attractive display, blister-box.

Order Number	Disc	Pack	Std. Carton
653X	black/SS	Viz Pack	6
830	SS Replacement head	Viz Pack	6
7071	Universal fender mount		

UNIVERSAL

5" X 7" head features stainless steel finish, vinyl cushioned glass, adjustable mounting ball. Direct replacement for PM 653X and similar competitive units. Packaged in a full-view clamshell.

Order Number	Disc	Pack	Std. Carton
830	stainless steel	Viz Pack	Sold ea

REPLACEMENT CHEVROLET/GMC PICKUP AND VAN

Direct replacement for Chevy and GMC mirrors, while its universal design fits most full-size pickups and vans, left and right application. Large 9 3/4" x 7" mirror head mounts below eye level for an unobstructed view. All stainless steel construction. 657C features ABS chrome plated head. Packaged in an attractive display, blister-box.

Order Number	Disc	Pack	Std. Carton
657X	stainless steel	Viz Pack	Sold ea
*657C	ABS chrome	Viz Pack	6

REPLACEMENT UNIVERSAL SWING-AWAY

Universal design, fits most full-size pickups and vans, left and right application. Large 7 1/2" x 10 1/2" mirror head with cushioned glass set atop this long-arm, tripod assembly. All stainless steel construction. Swingaway arm design. Packaged in an attractive display, blister-box.

Order Number	Disc	Pack	Std. Carton
810	stainless steel	Viz Pack	Sold ea
832	repl. head	Viz Pack	Sold ea

REPLACEMENT CHEVROLET/GMC FULL-SIZE PICKUP

Direct replacement for Chevy and GMC pickups, 1989 to 1995, with vent window pillar-mount mirrors. Large 9 1/4" x 6 3/4" stainless steel mirror head mounts on a black zinc base. Below eye level design. Right-hand mirror features convex mirror glass. Packaged in an attractive display, blister-box.

Order Number	Disc	Pack	Std. Carton
812L	LH stainless steel	Viz Pack	6
812R	RH stainless steel	Viz Pack	6

REPLACEMENT FORD PICKUP AND VAN

Direct replacement for Ford mirrors, while its universal design fits most full-size pickups and vans, both left and right application. 8 3/4" x 6" stainless steel mirror head mounts on an anodized aluminum arm for corrosion-free service. Two-point, swing-away bracket avoids damage from impact. Packaged in an attractive display, blister box.

Order Number	Disc	Pack	Std. Carton
815	stainless steel	Viz Pack	Sold ea
833	reel. head SS	Viz Pack	Sold ea



MIRRORS

C MIRRORS



UNIVERSAL GM STYLE

Rectangular 10 1/2" x 7 1/2" head with vinyl cushioned glass. 606 is a white ABS head, 831 is an ABS head with a paintable, matte black finish, replacement for PM 820. 832 is a stainless steel head that is a direct interchange for original equipment heads, PM 810 and 821, as well as most competitive models. Packaged in a full-view clamshell.

Order Numbers	Disc	Pack	Std. Carton
606	white	Viz Pack	Sold ea
*831	black	Viz Pack	6
832	stainless steel	Viz Pack	Sold ea

UNIVERSAL FORD STYLE

Direct replacement for 1987 and prior Ford mirrors, PM 815 and most competitive models. Universal design fits both full and down-sized pickups and vans. 8 1/2" x 5 11/16" stainless steel head features vinyl cushioned glass. Left and right hand application. Packaged in a full-view clamshell.

Order Number	Disc	Pack	Std. Carton
833	stainless steel	Viz Pack	6

UNIVERSAL FORD STYLE

Direct replacement for 1988 to 1992 Ford mirrors. Aerodynamic, wedge-shaped, stainless steel mirror heads feature 8 1/2" x 5 11/16" cushioned mirror glass. Left side features flat glass and right side has convex glass. Packaged in a full-view clamshell.

Order Numbers	Disc	Pack	Std. Carton
*834L	LH stainless steel	Viz Pack	6
*834R	RH stainless steel	Viz Pack	6

UNIVERSAL

Universal, left or right hand replacement heads for all two-point, swing-away style mirrors. 8 1/2" x 5 11/16" corrosion-free mirror heads are ideal for all vehicles. Heads are molded ABS, 835 is black and 836 is chrome-finished. Replacements for PM 822 and 823 as well as other competitive units. Packaged in a full-view clamshell.

Order Numbers	Disc	Pack	Std. Carton
835	black	Viz Pack	Sold ea
*836	chrome	Viz Pack	6

ARM EXTENSION

Chrome-plated brass will never corrode. 3" extension permits the mirror head on most three-point mirrors to move outward to increase visibility. Ideal for seeing around wide loads, campers or trailers. Packaged on a colorful blister card.

Order Number	Disc	Pack	Std. Carton
V808	chrome	Viz Pack	Sold ea

ADJUSTABLE WEDGE BLIND SPOT

2 3/16" x 1 1/2" convex mirror glass is adjustable to maximize the field of view. Molded ABS housing with an adhesive back permanently mounts to any clean, flat surface. Perfect accessory for any vehicle application. Packaged one per colorful display card.

Order Number	Disc	Pack	Std. Carton
V599	adjustable wedge	Viz Pack	Sold ea

2" ROUND BLIND SPOT

Convex 2" diameter glass, molded, black corrosion-free housing. Weather-resistant adhesive back sticks to any clean, flat surface. Packaged one per display card.

Order Number	Disc	Pack	Std. Carton
V600	round convex	Viz Pack	Sold ea
(7072)			

3 3/4" ADJUSTABLE BLIND SPOT

Totally unique, adjustable 3 3/4" diameter blindspot mirror. Mirror will rotate after installation to provide maximum field of view on any vehicle. Never again does the view of the blind spot mirror have to be limited by the regular mirror to which it is attached. Adhesive back mounts to any clean, flat surface. Packaged one per display card.

Order Number	Disc	Pack	Std. Carton
V601	adjustable convex	Viz Pack	ea
(7073)			

4" x 5 1/2" RECTANGULAR BLIND SPOT - Obsolete

4" x 5 1/2" convex mirror glass in a molded, black, corrosion-free housing. Adhesive back permanently installs to any clean, flat surface. Packaged one per display card.

Order Numbers	Disc	Pack	Std. Carton
V602	rectangular convex	Viz Pack	ea

7074 2" x 2" Square convex ea

7075 3" x 3" Square Convex ea

3" ROUND BLIND SPOT

Convex glass 3" over-all diameter, molded, black, corrosion-free housing. Weather-resistant adhesive back.

Packaged one per display card.

Order Numbers	Disc	Pack	Std. Carton
V603	round convex	Viz Pack	Sold ea
*B603	round convex		Sold ea

3 3/4" ROUND BLIND SPOT

Convex 3 3/4" overall diameter, molded black, corrosion-free housing. Reflective area 3 5/8" diameter. Weather-resistant adhesive back. Packaged one per display card.

Order Numbers	Disc	Pack	Std. Carton
V603L	round convex	Viz Pack	Sold ea
*B603L	round convex	mfg. pack	48

FLAT GLASS

5" mirror has a 5/16" internal-thread, female adjustable ball stud and bright-plated, right angle bracket. Finished in baked, black enamel for corrosion-resistance. Packaged in a see-through display box.

Order Number	Disc	Pack	Std. Carton
*605	black	box	12

CLAMP-ON CONVEX MIRROR

Clamp-on 4 3/4" mirror series features a durable, ABS housing, black or chrome finish, and bright-plated bracket for corrosion-resistant service. Unit will clamp on any round mirror assembly to increase visibility.

Order Numbers	Disc	Pack	Std. Carton
*V809	black-convex	Viz Pack	6
*V809X	chrome-convex	Viz Pack	6

5" CONVEX MIRROR

5" convex mirror with a 5" universal clamp-on mounting kit and right-angle bracket. Series can be mounted to bottom of any West Coast mirror or clamp on arm of any assembly. 654 has a black enamel finish and the 654X is stainless steel. Packaged in a see-through box.

Order Numbers	Disc	Pack	Std. Carton
*654	black	box	12
*654X	stainless steel	box	12

6" CONVEX MIRROR

6" convex mirror series with 5/16" adjustable female ball stud. Both a bright-plated, right-angle bracket and universal clamp-on mounting bracket are included. Mirror can be mounted to bottom of any West Coast mirror or clamp on arm of any assembly. 655 features baked black enamel finish and the 655X is stainless steel. Packaged in a see-through box.

Order Numbers	Disc	Pack	Std. Carton
*655	black	box	12
655X	stainless steel	box	Sold ea

8" ELLIPTICAL CONVEX MIRROR

8" computer designed convex surface provides maximum viewing area. When properly mounted, all dangerous blind spots are eliminated. A bright-plated, right angle bracket with 5/16" adjustable ball stud are included. 607 is finished in black enamel.

Order Numbers	Disc	Pack	Std. Carton
*607	black	box	1

8" CONVEX MIRROR

8" convex mirror with bright-plated, right angle bracket permits installation to any West Coast mirror assembly. Unit securely held in place with 5/16" adjustable ball stud. 608 is finished in black enamel and 608X is stainless steel. Packaged in a see-through box.

Order Numbers	Disc	Pack	Std. Carton
608	black	box	Sold ea
*608X	stainless steel	box	6

8" CONVEX MIRROR

8" convex mirror with an offset stud, all other quality features as listed above. Offset mounting positions the convex mirror below the West Coast mirror head increasing the rear viewing area. 608X0 is stainless steel. Packaged in a see-through box.

Order Numbers	Disc	Pack	Std. Carton
*608X0	stainless steel	box	6



C

MIRRORS

C

MIRRORS

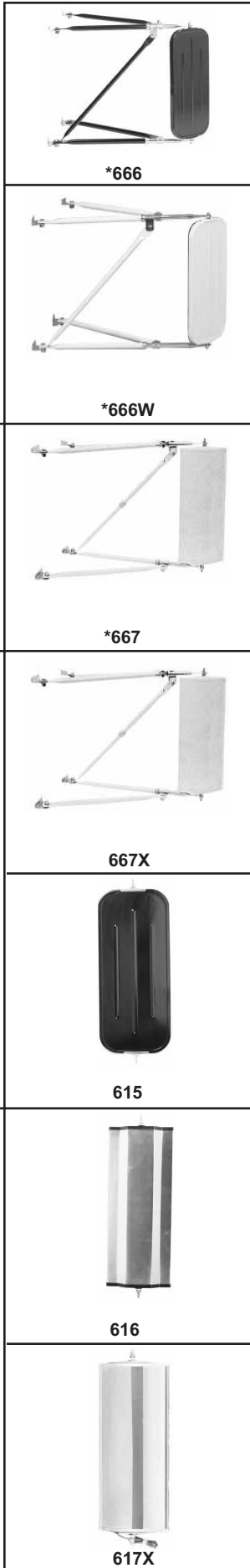

WEST COAST ASSEMBLY
 7" x 16" head is heavy gauge steel finished in baked black enamel. Heavy gauge 3/4" arms and sturdy reinforcing brace reduce flutter and vibration. 18" to 25" horizontal adjustment. All mounting hardware and instructions included. Uses head number 616.

Order Numbers	Disc	Pack	Std. Carton
*666	complete assembly	box	6

WEST COAST ASSEMBLY
 Same as 666 except finished in baked white enamel. 18" to 25" horizontal adjustment. Uses head number 616W.

Order Numbers	Disc	Pack	Std. Carton
*666W	complete assembly	box	6

WEST COAST ASSEMBLY
 6 1/2" x 16" pillowed-back head is heavy gauge steel finished in white enamel. Domed end caps assure rigidity and protect glass. Heavy gauge 3/4" arms and brace are bright plated. 18" to 25" horizontal adjustment. Uses head number 617.

Order Numbers	Disc	Pack	Std. Carton
*667	complete assembly	box	6

STAINLESS STEEL WEST COAST ASSEMBLY - Sold Each
 Polished stainless steel version of the 667 series. Heavy gauge 3/4" arms and brace are bright plated for maximum corrosion resistance. 18" to 25" horizontal adjustment. Uses head number 617X.

Order Numbers	Disc	Pack	Std. Carton
667X	complete assembly	box	Sold ea

ECONOMY 6112" X 16" - Sold Each
 Most cost effective replacement head available. Unit has a durable anodized aluminum back with polycarbonate end caps for superior quality. The 615 series utilizes 1/4" mounting studs. Packaged in a see-through box.

Order Numbers	Disc	Pack	Std. Carton
615	aluminum	box	Sold ea

RIBBED FLAT BACK 7" X 16"
 OEM style, universal replacement mirror head. Sturdy one-piece design. 5/16" mounting studs and cushioned glass make this series very popular and durable. 616 has a black enamel finish and 616W finished in white enamel. Packaged in a see-through box.

Order Numbers	Disc	Pack	Std. Carton
616	black	box	Sold ea
*616W	white	box	6

PILLOW BACK 6 1/2" X 16"
 Superior design and universal application make this a very popular series. 617 is finished in baked white enamel. 617X features bright, corrosion-proof stainless steel back and end caps. 617XH is a heated version of the 617X. The 2-wire system with resistance type heater generates uniform heat over the entire mirror surface. All utilize 5/16" center rod construction. Packaged in a see-through display box.

Order Numbers	Disc	Pack	Std. Carton
*617	white	box	6
617X	stainless steel	box	Sold ea
*617XH	stainless steel heated	box	6

EXTENDABLE REPLACEMENT MIRRORS



- Fits OE Mounting, NO DRILLING REQUIRED!
- Fold-away & break-away feature for tight spaces
- 2-1/2"x3-3/4" wedge spot mirrors included
- Mirror face available in Manual, Electric, & Heated
- 10"x10" mirror face for unsurpassed visibility!
- Manually extends or retracts 4.25"

Year	Model	Manual	Electric	Heated
CHEVY/GMC				
1988 - 2000	CK Pickup, Sierra, Denali			
1992 - 1999	Suburban, Yukon	CA 80000	CA 70000	CA 70500
1995 - 1999	Tahoe			
2000	Tahoe Limited			
1999 - 2002	Silverado, Sierra			
2000 - 2002	Suburban, Tahoe, Yukon, Yukon XL	CA 80100	CA 70100	CA 70600
2003 - 2006	Silverado, Sierra, Suburban, Tahoe, Yukon, Yukon XL	CA 80100	CA 70200	CA 70700
DODGE				
1994 - 1997	Ram Pickups	CA 83000	CA 73000	CA N/A
1998 - 2001	Ram 1500	CA 83000	CA 73100	CA 73500
1998 - 2002	Ram 2500 & 3500			
2002 - 2006	Ram 1500	CA 83100	CA 73200	CA 73600
2003 - 2006	Ram Pickups			
FORD				
1997 - 2002	F-150 Pickups (except Super Crew)	CA 82000	CA 72000	N/A
1998 - 2006	HD Pickups (F-250 & F-350)	CA 82100	CA 72100	CA 72500

Extendable Replacement Mirrors are not recommended for vehicles with additional features such as memory and puddle lights

UNIVERSAL TOWING MIRROR



Fully adjustable mirror. Movable feet, securing clamps and tightening knob for a secure fit without annoying vibration! Aerodynamic and durable styling.

CA11960 Universal Towing Mirror

DUAL-VIEW CLIP-ON MIRROR



Two fully-adjustable mirror surfaces! Large flat mirror surface, plus a convex 'blindsport' mirror. Fully-enclosed mirror head, adjustable arms and rubber straps. Fits mirrors 7" to 10" tall.

CA11953 Dual View Clip On

CLIP-ON TOWING MIRROR



Easy-to-adjust arms for many applications. Rubber straps secure mirror to your vehicle's existing mirror.

CA11950 Clip-On Towing Mirror

FAST HITCH MIRROR



Gives driver a clear, unobstructed view of hitch and ball for alignment. Attaches with arms on truck gate, or suction cups to rear window.

CA11955 Fast Hitch

ADJUSTABLE CLIP-ON MIRROR



Designed with larger mirrors in mind. Adjustable mirror fits mirrors from 7" to 10" tall. Rubber straps secure mirror to vehicle's existing mirror.

CA11952 Adjustable Clip-On Mirror

SLIDE-OUT TOWING MIRROR



Slides out an extra 5". Installs quickly, replaces existing mirror head

CA95150 GMC/Chevy/Dodge
CA95155 Window Mount Chevy

DELUXE DOOR MOUNT MIRROR



Fits most cars, trucks and vans. Installs in seconds, includes non-scratch mounting pads. Extends 17" from vehicle. Replacement Head #95400 on page 8.

CA11650 Deluxe Door Mount

FENDER MOUNT MIRROR



Fits most cars and small trucks. 5" x 7" Stainless head with easy mounting features. Extends 15" from vehicle. Replacement Head #95117 on page 8.

CA11750 Fender Mount Mirror

CAMPER MOUNT MIRROR



Mounts to camper for better towing vision. Has a 5" x 7" mirror head. Replacement Head #95117 on page 8.

CA11850 Camper Mount Mirror

MIRRORS

C
HITCH COVERS

 TM30003 6431	 40113 1 1/4" 40114 2"	 TM80002	 TM60011 6433	 8895 - 1 1/4" 8896
 1202	 1944	 6434	 5330	 6788
 5363 7050 5362 1 1/4"			 WSL 74191	 2211
 HC420				



Dust cover conceals & protects dials

Easily set your own combination

Store spare keys for your car, boat or home. Great for securing credit cards and cash during outdoor activities.

Sliding bars secure Hitch Pins from the inside

HS7000
HITCH SAFE KEY VAULT



HS7021T

TOYOTA PINS FOR HITCH SAFE
PAIR BAGGED
05-06 TACOMA NEEDED BECAUSE OF
EXTRA THICK RECEIVER TUBE



HC122



HC122L



HC127L



HC127



HC203



HC205



HC601



HC703

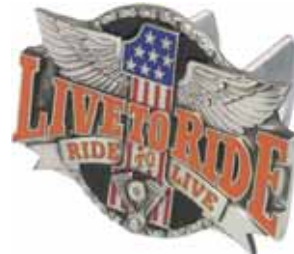

HC808



HC907L



HC602



HC705



HC815



HC805



HC911L



HC603



HC814



HC425L

C
HITCH COVERS